



# Innovative Solutions in **Advanced Surgical** 2022 **Positioning**

Visit Us Online [schuremed.com](http://schuremed.com)

Email [orders@schuremed.com](mailto:orders@schuremed.com)

Ph 781.236.4151 | Fax 781.982.7001



**SHOULDER Surgery**  
Powered Beach Chair  
E-Z Lift Beach Chair  
Schure Loc XPS

**GYN/LAPRO/URO**  
HD 1000 Boot System  
Platinum Stirrups  
Premium Stirrups

**KNEE SURGERY**  
24" & 30" TKR  
SchureFoot, Lexan

**SPINE SURGERY**  
Schure Spine Frame

**TABLE EXTENSIONS**  
Adj. Footboard/Table Ext.  
Foot Extension

**DISPOSABLES**  
Head & Chin Straps  
Face Masks

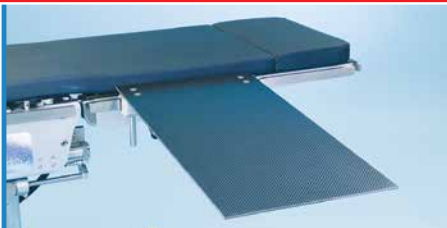



## SCHUREMED—THE BETTER CHOICE

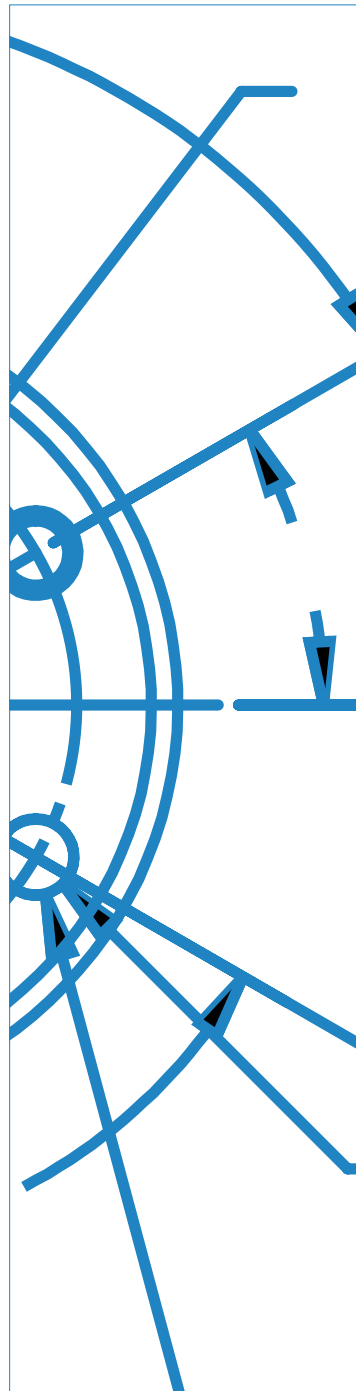

- High-Quality Products at Reasonable Prices
- Expert Engineering and Manufacturing services
- Excellent Customer Service

SchureMed is one of the world's leading manufacturers of operating room products specializing in surgical table accessories and positioners.

Patient positioning is our focus and creating safe and effective patient positioning products is our priority. These principles guide the design of all our products. We offer products for Gynecology, Urology, Laparoscopy, Orthopedic and General Surgery procedures.

SchureMed offers a complete line of surgical table accessories for your positioning needs. Some of our featured products include our Great White® Stirrups for lithotomy positioning, our Powered and E-Z Lift Beach Chairs for shoulder surgery, the Schure Spine Fame for posterior approach spine surgery, the Schure Loc XPS Limb Positioner and TKR Positioner for total knee replacement procedures.

SchureMed is proud to have achieved an ISO 13485: 2016 Certification as of August 5, 2020. This Certification demonstrates SchureMed's commitment to quality management processes and ensures best practices in everything we do. All of our products are proudly made in the United States in our Abington, MA manufacturing facility and are shipped worldwide.

We invite you to contact us with any questions you may have regarding our innovative products and our high-quality manufacturing and design services.

Ph [781-236-4151](tel:781-236-4151)  
 Fax [781-982-7001](tel:781-982-7001)  
 Email [orders@schuremed.com](mailto:orders@schuremed.com)  
 Website [schuremed.com](http://schuremed.com)

## TABLE OF CONTENTS

<p><b>4-15 GYN/LAPRO/URO SURGERY</b>                  Candy Cane Stirrups..... 13                  Clear View Leg Drapes ..... 15                  Great White® HD 1000 Stirrup Boot System ...6-7                  Great White® Maxima Stirrups ..... 11                  Great White® Platinum Stirrups .....8-9                  Great White® Premium Stirrups..... 10                  Great White® Robotic Stirrups ..... 12                  Stirrup Dolly .....9-11                  Knee Crutches..... 13                  Lithotomy Stirrups..... 12                  Lithotomy Stirrup Dolly..... 12, 14                  Pediatric E-Z Lift Stirrups ..... 14                  Pediatric Lithotomy Stirrups..... 14                  Pediatric Stirrup Dolly ..... 14                  Robotic Stirrup Dolly ..... 12                  SchureMed Surgical Stirrup Comparison Chart... 5                  Split Leg Stirrups..... 13                  Stirrup Wall Rack ..... 9, 10                  Uro-Trapper Drain Bags..... 15                  Uro-Trapper System..... 15</p> <p><b>16-21 SHOULDER SURGERY</b>                  Complete Shoulder System ..... 17                  E-Z Lift Beach Chair..... 18-19                  Powered Beach Chair ..... 16-17                  Shoulder Chair Dolly..... 17, 19                  Schure Loc™ XPS &amp; Accessories..... 20-21</p> <p><b>22-25 KNEE SURGERY</b>                  Arthroscopic Leg Holder..... 25                  SchureFoot Disposable Pads ..... 24                  TKR Boot Liners ..... 23                  SchureFoot for TKR ..... 24                  Schure Grip Leg Holder ..... 25                  TKR Positioner ..... 22-23</p> <p><b>26 SPINE SURGERY</b>                  Schure Spine Frame &amp; Accessories ..... 26</p> <p><b>27 PATIENT POSITIONING</b>                  Lateral Braces ..... 27                  Lateral Positioners..... 27                  Surgical Peg Board System ..... 27</p> <p><b>28-29 TABLE CLAMPS</b>                  CamLoc Rail Clamp..... 28                  Deluxe Rail Clamp ..... 29                  Schure Socket..... 29                  Schure Socket XL..... 28                  Simple Clamp..... 29                  SpringLoc Clamp..... 28                  Universal Rail Clamp ..... 29</p>	<p><b>30-31 TABLE EXTENSIONS</b>                  Adjustable Footboard/Table Extension ..... 30                  Bariatric Foot Extension ..... 31                  Foot Extension..... 30                  Narrow Headrest ..... 31                  Table Width Extensions ..... 31                  Wrist Rest..... 31</p> <p><b>32-33 ARMBOARDS</b>                  Adjustable Height Armboard ..... 32                  Armboard Wall Rack ..... 33                  Extra-Wide Armboard ..... 32                  Extra-Wide Adjustable Armboard ..... 32                  Incline Armboard Pad ..... 33                  Radiolucent Armboard..... 33                  Standard Armboard ..... 32</p> <p><b>34 SURGICAL ARM SUPPORTS</b>                  Lateral Arm Support..... 34                  Multi-Axis Arm Positioner ..... 34</p> <p><b>35 PROCEDURE HAND TABLES</b>                  Minor, Major, Hourglass &amp; End Rest..... 35</p> <p><b>36 LEG PREPPERS</b>                  Bi-Lateral, Universal &amp; Leg ..... 36</p> <p><b>37-41 SURGICAL TABLE ACCESSORIES</b>                  Anesthesia Screen..... 38                  Comfort Mat..... 39                  Disposable A-Line Positioners ..... 40                  Disposable Face Masks ..... 37                  Premium Head &amp; Chin Straps ..... 37                  Elbow Arthroscopy Support..... 38                  Extremity Positioner..... 41                  Nissen Straps: Regular &amp; Bariatric ..... 40                  Restraint Straps: Regular &amp; Bariatric ..... 40                  Safety Draw: IV Pole and Mayo Stand Mounts .. 39                  Saphenous Vein Harvesting Pad ..... 41                  Schure Strap Brand Rolls ..... 37                  Toboggan Arm/Leg Guards..... 38                  Well Leg Holder..... 41                  Wrist Tower ..... 39</p> <p><b>42-43 COATED &amp; DISPOSABLE POSITIONING PADS</b></p> <p><b>44-45 PATIENT TRANSFER DEVICES</b>                  Schure Slides ..... 45                  Schure Slides FTS ..... 44</p> <p><b>46-47 ARMBOARD PADS - Flat &amp; Contoured</b></p> <p><b>48-51 PRODUCT INDEX</b></p>
--	--

*All products are not made with natural rubber latex*

SCHUREMED—THE BETTER CHOICE

TABLE OF CONTENTS

GYNECOLOGY/LAPAROSCOPY/UROLOGY



SchureMed™ Surgical Stirrup Comparison Chart

	PRODUCT	Patient Weight Limit	Protective Fin Design	Lift Mechanism	Lithotomy Adjustment (From Sterile Field)	Lithotomy Range (From Sterile Field)	Abduction Adjustment (From Sterile Field)	Abduction Range (From Sterile Field)	Lithotomy Indicator
BEST	<b>Great White® HD 1000 Stirrups</b> #800-0364	1,000 lbs. (454 kg)	Yes	Yes	Yes All Positions in Range	+75°, -25° External Rotation 20°	Yes All Positions in Range	+25°, -9°	Yes (on rod)
	<b>Great White® Maxima Stirrups</b> #800-0342-M	800 lbs. (363 kg)	Yes	Yes	Yes All Positions in Range	+75°, -30° External Rotation 20°	Yes All Positions in Range	+25°, -9°	Yes (on rod)
	<b>Great White® Platinum Stirrups</b> #800-0342-PL	600 lbs. (272 kg)	Yes	Yes	Yes All Positions in Range	+75°, -30° External Rotation 20°	Yes All Positions in Range	+25°, -9°	Yes (on rod)
	<b>Great White® Robotic Stirrups</b> #800-0342-RF	600 lbs. (272 kg)	Yes	Yes	Yes All Positions in Range	+60°, -55° External Rotation 20°	Yes All Positions in Range	+25°, -9°	Yes (on rod)
BETTER	<b>Great White® Premium Stirrups</b> #800-0342-PR	400 lbs. (181 kg)	No	Yes	Yes All Positions in Range	+75°, -30° External Rotation 20°	Yes All Positions in Range	+25°, -9°	Yes (on rod)
GOOD	<b>Lithotomy Stirrups</b> #800-0049	350 lbs. (159 kg)	Yes	No	No	N/A	N/A	N/A	N/A
	<b>Candy Cane Stirrups</b> #800-0012	350 lbs. (159 kg)	No	No	No	N/A	N/A	N/A	N/A
PEDIATRIC	<b>Pediatric E-Z Lift Stirrups</b> #800-0342-PUPS #800-0342-KIDS	PUPS: 160 lbs. (73 kg) KIDS: 250 lbs. (113 kg)	No	Yes	Yes All Positions in Range	+75°, -30° External Rotation 20°	Yes All Positions in Range	+25°, -9°	Yes (on rod)
	<b>Pediatric Lithotomy Stirrups</b> #800-0233 PUPS #800-0234 KIDS	PUPS: 160 lbs. (73 kg) KIDS: 250 lbs. (113 kg)	No	No	No	N/A	N/A	N/A	N/A



GYNECOLOGY/LAPAROSCOPY/UROLOGY

# Great White® HD 1000 Stirrup Boot System

1,000 lb. (454 kg)  
Patient Wt. Capacity



Watch VIDEO  
[schuremed.com/videos](http://schuremed.com/videos)



Patent Pending

## GYNECOLOGY/LAPAROSCOPY/UROLOGY

### Great White® HD 1000 Stirrup Boot System



Select from the included (A) Bariatric Maxima, (B) Platinum and (C) Premium Boots.

Quick and easy connection reduces setup time making it a cost-effective.

## Discover our NEW Interchangeable Stirrup Boot System with 1,000 lb. Patient Weight Capacity

### Features

- **Proprietary 3-in-1 System** includes three pairs of Stirrup Boots: Premium, Platinum & Bariatric
- **Stronger!** A new, engineered stainless steel tube increases patient weight capacity to 1,000 lb. (454 kg)
- **Redesigned!** 3-axis control handle mimics the human hip's motion for smooth and accurate high/low lithotomy, adduction & abduction positioning
- **Locking Gas Spring** locks stirrup in place - stays locked until trigger is pulled
- **Capacity** 1,000 lb. (454 kg) patient weight
- **Ranges** Lithotomy Range -25° low to 75° high; Adduction 9° and abduction +25°
- **Included** Premier boot liners wrap the foot, ankle & calf providing safe, comfortable & secure patient positioning
- **Reduced Setup** Quick, easy connection reduces setup time, training and downtime
- **Easily Repositions** Lithotomy indicators for accurate repositioning of legs

**#800-0364** Great White® HD 1000 Stirrup Boot System  
Required Accessory: Purchase Two SpringLoc Clamps  
**#800-0338**  
**#800-0338-EU**  
**#800-0338-JPN**  
**#800-0338-SWISS**

Optional Accessories  
**#800-0160** Clear View Leg Drapes, Sterile, 10/cs\*  
\*Sterile products are non-returnable.

Replacement Pads  
**#508-1354** Premium Stirrup Boot Pads, Set  
**#508-1415** Platinum Stirrup Boot Pads, Set  
**#508-1502** Bariatric Stirrup Boot Pads, Set

600 lb. (272 kg)  
Patient Wt. Capacity

## Great White® Platinum Stirrups

## GYNECOLOGY/LAPAROSCOPY/UROLOGY



### Great White® Platinum Stirrups

- Exclusive 3-axis control from the handle
- Patient weight capacity up to 600 lbs. (272 kg)
- Boots free-float throughout lithotomy range
- Clam shell stirrup boot liners contain the foot, ankle and calf for maximum patient security and comfort
- Lithotomy and length indicators assist with accurate positioning of legs

The Great White® Platinum Stirrups provide safe and quick positioning assistance for improved surgical site access. This intra-operative, adjustable medical stirrup for gynecological, laparoscopic, and urological applications offers exceptionally precise placement, effectively minimizing the possibility of nerve damage. Exclusive axial rotation, high/low lithotomy and abduction/adduction from the handle improves patient positioning.

Simply squeeze the trigger for smooth and accurate patient adjustment without jeopardizing sterility or patient comfort. Once the trigger is released, the stirrup is firmly locked for optimum safety and surgical performance. The mounting blade design quickly and easily inserts into side-rail clamps. The raised lateral boot fin system protects the patient from superficial nerve damage.

The enhanced range of motion allows for -30° for low lithotomy, to 75° high lithotomy; adduction 9° to abduction 25° and also externally rotates out 20°. The Great White® Platinum Stirrups are delivered fully assembled with included boot liners. Two required SpringLoc Clamps sold separately.

**#800-0342-PL** Great White® Platinum Stirrups

**SpringLoc Clamp: Required Accessory: Purchase Two**

**#800-0338**

**#800-0338-JPN**

**#800-0338-EU**

**#800-0338-SWISS**

*Optional Accessories*

**#800-0074-S** Stirrup Dolly

**#800-0284** Great White® Stirrup Wall Rack

**#800-0160** Clear View Leg Drapes, Sterile, 10/cs\*

\*Sterile products are non-returnable.

*Replacement Pads*

**#508-1415** Platinum Stirrup Boot Pads, Set

**#508-0350** Yellofin Boot Pads



**#800-0074-S** Stirrup Dolly



**#800-0160**  
Clear View Leg Drapes



**#800-0284** Stirrup Wall Rack



**#800-0338** SpringLoc Clamp



Watch VIDEO  
[schuremed.com/videos](http://schuremed.com/videos)



Patent Pending

**GYNECOLOGY/LAPAROSCOPY/UROLOGY**

**GYNECOLOGY/LAPAROSCOPY/UROLOGY**

#800-0342-PR Exclusive axial rotation from the handle for superior patient positioning



Exclusive 3-axis control

400 lb. (181 kg)  
Patient Wt. Capacity  
Patent Pending

#800-0342-PRF

**Great White® Premium Stirrups**

- Exclusive axial rotation from the handle for superior patient positioning
- Lift assist allows easy control with minimal effort
- Flexible boot accommodates larger patients
- 400 lb. (181 kg) patient weight capacity
- Better patient ergonomics
- Rotates on three axes
- Boot pads are included

High quality, feature-rich, and priced right, the Great White® Premium Stirrups are exactly what your surgical team requires. The enhanced range of motion allows for -30° for low lithotomy, to 75° high lithotomy; adduction 9° to abduction 25° and also externally rotates out 20°.

#800-0342-PR Premium Stirrups w/o Fins, pr  
#800-0342-PRF Premium Stirrups w/Fins, pr

SpringLoc Clamp: Required Accessory: Purchase Two

#800-0338 #800-0338-JPN  
#800-0338-EU #800-0338-SWISS

**Optional Accessories**

#800-0074-S Stirrup Dolly  
#800-0284 Stirrup Wall Rack  
#800-0160 Clear View Leg Drapes, Sterile, 10/cs\*  
\*Sterile products are non-returnable.

**Replacement Pads**

#508-1354 Premium Stirrup Boot Pads, Set  
#508-1415 Platinum Stirrup Boot Pads, Set

Allow visibility of patient's leg during intra-operatively adjustments with Clear View Drapes (left). Organize your accessories with the Stirrup Dolly (center) and Stirrup Wall Rack (right).



Exclusive 3-axis control

800 lb. (363 kg)  
Patient Wt. Capacity

Patent Pending

**Great White® Maxima Stirrups**

- Exclusive axial rotation from the handle for superior patient positioning
- A wide boot and a stronger gas cylinder make this stirrup perfect for your heaviest patients
- 800 lb. (363 kg) surgical patient weight capacity
- Boot free-floats throughout each range reducing the risk of superficial nerve injury
- Lithotomy and length indicators help to position and reposition the legs
- Extended lateral boot design helps reduce the risk of peroneal nerve injury

Increase your surgeons' operating room performance with the Great White® Maxima Stirrups which permit simple adjustment of lithotomy and abduction intraoperatively. Exclusive axial rotation from the handle for superior patient positioning. Great White® Maxima Stirrups range of motion

#800-0074-S



Fold-over design



is -30° low lithotomy to 75° high lithotomy. Adduction 9°, abduction 25° and also externally rotates out 20°, with the control to lock the stirrup anywhere in between. The Great White® Maxima Stirrups ship fully assembled. Boot pads are included. Two required SpringLoc Clamps sold separately.

#800-0342-M Great White® Maxima Stirrups

SpringLoc Clamp: Required Accessory, Order 2

#800-0338 #800-0338-JPN  
#800-0338-EU #800-0338-SWISS

**Optional Accessories**

#800-0074-S Stirrup Dolly  
#800-0284 Stirrup Wall Rack  
#800-0160 Clear View Leg Drapes, Sterile, 10/cs\*  
\*Sterile products are non-returnable.

**Replacement Pads**

#508-1502 Bariatric Stirrup Boot Pads, Set

**GYNECOLOGY/LAPAROSCOPY/UROLOGY**



**Lithotomy Stirrups**

- Use for long or short procedures
- Soft boot pads encapsulate feet
- 350 lb. (159 kg) patient weight capacity
- Features extended lateral boot support to prevent superficial nerve damage and unwanted leg rotation
- Schure Sockets sold separately, purchase two

**#800-0049** Lithotomy Stirrups  
**#800-0006** Schure Socket  
**#800-0074-L** Lithotomy Stirrup Dolly  
*Replacement Pads*  
**#508-1415** Platinum Stirrup Boot Pads, Set

**GYNECOLOGY/LAPAROSCOPY/UROLOGY**

**Candy Cane Stirrups**

- Adjust vertically from 28"-44" (71 cm-112 cm) with an 8" (20 cm) leg clearance
- 18"L x 1.5"W (46 cm x 4 cm) double-looped, cotton ankle strap
- Lock stirrup height by simply twisting the ergonomic handle
- Connects with Schure Socket XL (sold separately)

**#800-0012** Candy Cane Stirrups  
*Required Accessory: Order Two*  
**#800-0134** Schure Socket XL  
*Replacement Strap (sold individually)*  
**#790-0006** Candy Cane Stirrup Strap



**Great White® Robotic Stirrups**

- Flexible boot accommodates up to 600 lb. (272 kg) patients
  - Rotates on three axes
  - Lift assist allow easy control with minimal effort
- The mounting blade design quickly and easily inserts into side-rail clamps. The Great White® Robotic Stirrups' range of motion is -55° low lithotomy to 60° high lithotomy. Adduction 9° and abduction +25° and also externally rotates out 20°, with the control to lock the medical stirrup for positioning anywhere in between.

**#800-0342-RF** Great White® Robotic Stirrups w/Fins  
**#800-0342-R** Great White® Robotic Stirrups w/o Fins  
*Required Accessory: Order 2: SpringLoc Clamp*  
**#800-0338** **#800-0338-JPN**  
**#800-0338-EU** **#800-0338-SWISS**

*Optional Accessories*  
**#800-0074-R** Robotic Stirrup Dolly  
**#800-0284** Stirrup Wall Rack  
**#800-0160** Clear View Leg Drapes, Sterile, 10/cs\*  
 \*Sterile products are non-returnable.  
*Replacement Pads*  
**#508-1354** Premium Stirrup Boot Pads, Set  
**#508-1415** Platinum Stirrup Boot Pads, Set

**Split Leg Stirrups**

- Superior stirrups for lower extremity procedures
- Use for Vascular & Orthopedic procedures and mid-line access to abdomen

The Split Leg Positioners are radiolucent and lightweight. They are designed with excellent access to the operative site. The mounting blade design quickly and easily inserts into side-rail clamps.

**#800-0342-SL** Split Leg Stirrups  
*Required Accessory: Order Two*  
**#800-0228-SL** Split Leg Clamp  
*Optional Accessory*  
**#800-0324** Split Leg Footboards (not shown)



**Knee Crutches**

- Knee Crutches adjust vertically from 12"-19" (31 cm-48 cm) and rotate 360° to provide precise positioning with a simple ergonomic locking handle
- Constructed of the highest quality stainless steel
- Extremely soft and comfortable crutch liners prevent superficial nerve damage to the patient. Mount crutches simply with Schure Socket XL (sold separately)

**#800-0041** Knee Crutches  
*Required Accessory: Order Two*  
**#800-0134** Schure Socket XL  
*Replacement Pads*  
**#508-0154** Knee Crutch Pads



GYNECOLOGY/LAPAROSCOPY/UROLOGY

GYNECOLOGY/LAPAROSCOPY/UROLOGY



## GYNECOLOGY/LAPAROSCOPY/UROLOGY



Exclusive axial rotation from the handle for superior patient positioning

- E-Z Lift feature easily control the patient's leg when moving it into the operative position
- Floating boot automatically adjusts when repositioning the pediatric boot stirrup
- Range: Abduction +25°, Adduction 9°, Lithotomy range of +75° to -30° & externally rotates out 20°

### Pediatric E-Z Lift Stirrups

The Pediatric E-Z Lift Stirrups are easy-to-use with exclusive axial rotation from the handle for superior patient positioning. Boot adjusts with a single clamp which simplifies patient positioning. Boot pads included.

**#800-0342-PUPS** 160 lb. (73 kg) patient capacity  
**#800-0342-KIDS** 250 lb. (113 kg) patient capacity

**#800-0238** Pediatric E-Z Lift Stirrups Bundle  
*Includes 1 pair of each stirrup*

*SpringLoc Clamp: Required Accessory: Purchase Two*  
**#800-0338** **#800-0338-JPN**  
**#800-0338-EU** **#800-0338-SWISS**

#### Optional Accessories

**#800-0074-P** Pediatric Stirrup Dolly  
**#800-0160** Clear View Leg Drapes, Sterile, 10/cs\*  
*\*Sterile products are non-returnable.*

#### Replacement Pads

**#508-1295** PUPS Boot Pads  
**#508-1296** KIDS Boot Pads



- Pediatric boot stirrup design encapsulates patient's lower leg
- Floating boot automatically adjusts when repositioning the pediatric boot stirrup

### Pediatric Lithotomy Stirrups

The Pediatric Lithotomy Stirrups are a comfortable boot stirrup. Specifically designed with the pediatric patient in mind. Pediatric stirrups attach to side rail of any OR table using the Schure Socket XL (sold separately). Boot pads included.

**#800-0233** PUPS, 160 lb. (73 kg) patient capacity  
**#800-0234** KIDS, 250 lb. (113 kg) patient capacity

**#800-0237** Pediatric Lithotomy Stirrups Bundle  
*Includes 1 pair of each stirrup*

*Required Accessory: Order Two*  
**#800-0006** Schure Socket

#### Optional Accessories

**#800-0074-L** Lithotomy Stirrup Dolly  
**#800-0160** Clear View Leg Drapes, Sterile, 10/cs\*  
*\*Sterile products are non-returnable.*

#### Replacement Pads

**#508-1295** PUPS Boot Pads  
**#508-1296** KIDS Boot Pads

## GYNECOLOGY/LAPAROSCOPY/UROLOGY



### Uro-Trapper System

- Flexible drape support provides unobstructed surgeon access to surgical site and springs back to original orientation to allow for optimal fluid drainage
- Mounts effortlessly to any surgical table with integral clamps

A flexible system that attaches to any general surgical table to contain fluids for hysteroscopy or cystoscopy procedures.

**#800-0096** Uro-Trapper System



### Uro-Trapper Drain Bags

- Flexible hose is compatible with all suction systems for accurate fluid measurement
- Durable, drain bags are not made with natural rubber latex

Open mesh filter allows for rapid drainage of fluids. Tube is 64"L x 7/8"D (163 cm x 2 cm) and 20" (51 cm) compressed.

**#800-0095** Uro-Trapper Drain Bags, 10/cs  
**#800-0098** Uro-Trapper Drain Bags, Sterile, 10/cs\*  
*\*Sterile products are non-returnable.*



### Clear View Leg Drapes

The Clear View Leg Drape allows visibility of patient's leg during intraoperative adjustments. A blue modesty panel is now incorporated within the drape. Packaged sterile and not made with natural rubber latex. Provides continuous monitoring of patient's legs without breaking sterile field.

**#800-0160** Clear View Leg Drapes, Sterile, 10/cs\*  
*\*Sterile products are non-returnable.*





Completely eliminates manual positioning with push-button ease

Watch VIDEO [schuremed.com/videos](http://schuremed.com/videos)



Head system slides vertically and then locks tight.

## Powered Beach Chair

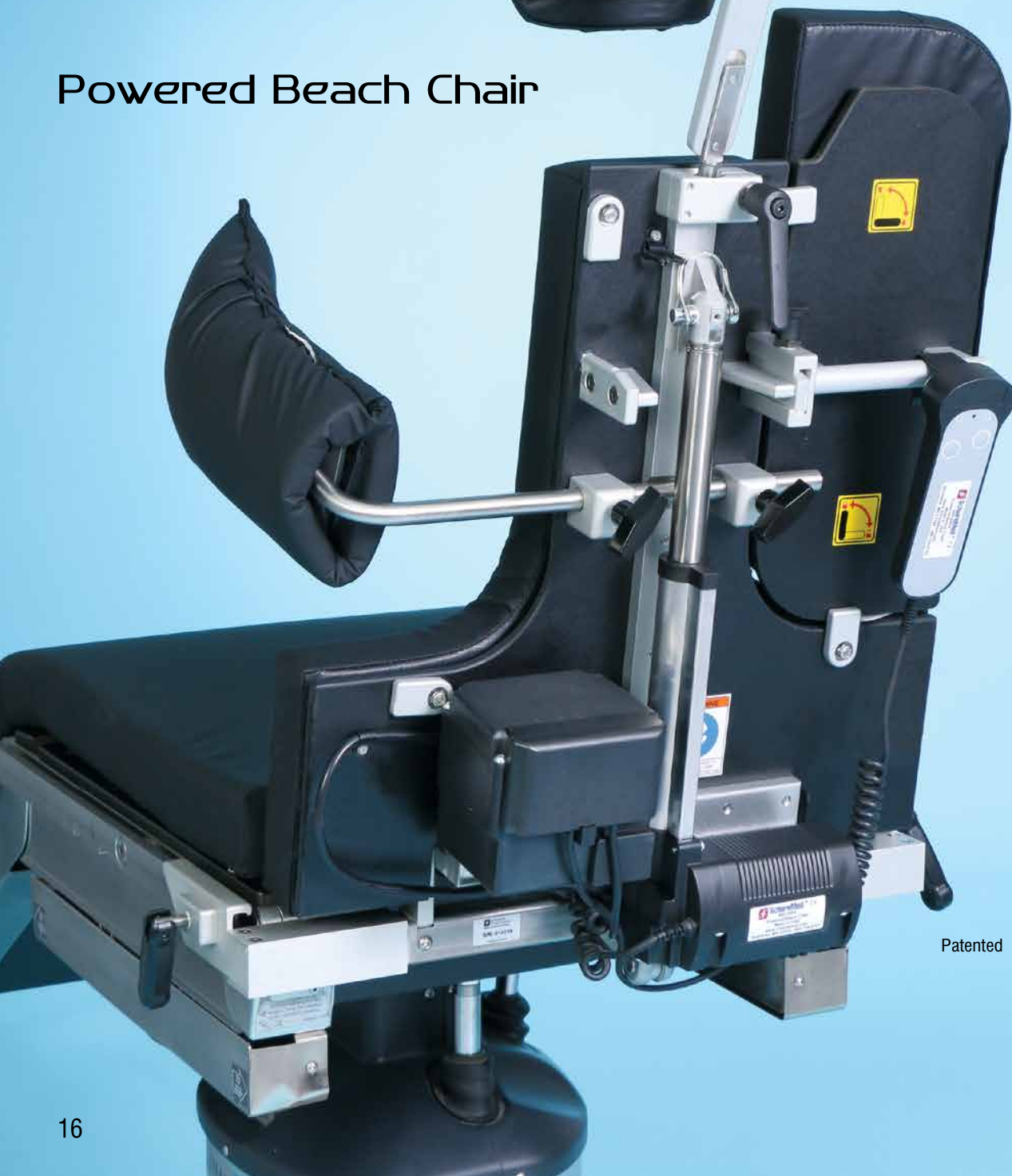

Patented

### Powered Beach Chair

- 500 lb. (227 kg) patient weight capacity
- Motion-control technology eliminates manual patient positioning
- Lateral Brace attaches to chair and not table side rail
- Pull-away panels providing excellent surgical exposure
- Double-ball joint head rest tilts 30° in every direction
- Five-piece Deluxe pad set included

The SchureMed Powered Beach Chair is the only chair on the market with a self-contained motor that does not have to rely on the surgical table for power. The double-ball joint head system safely secures patient's head even with kyphosis patients. Chair adjusts from 0-90° in 8 seconds in a smooth controlled movement. 2" (5 cm) Deluxe pad set provides patient comfort. Motion-control technology eliminates manual patient positioning with a simple push button hand control and supports patients up to 500 lbs. (227 kg). Attaches to ANY operating room table with our integrated adjustable mounting clamps. Lateral Brace included. All powered beach chairs include U.S. cables.

**#800-0004** Powered Beach Chair

*Required Accessories: Select One Model*

**#800-0164** Disposable Face Masks, 12/cs\*

**#800-0369** Premium Head & Chin Straps, 12/cs\*

\*Products are non-returnable.

*Optional Accessories*

**#800-0074** Shoulder Chair Dolly

**#800-0050** Multi-Axis Arm Positioner

**#800-0134** Schure Socket XL



Disposable Face Masks

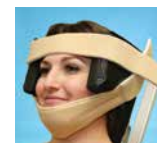

Premium Head & Chin Straps



Multi-Axis Arm Positioner



Schure Socket XL



Shoulder Chair Dolly,  
39"H x 27"W x 12"D  
(99 cm x 69 cm x 30 cm)



Watch VIDEO [schuremed.com/videos](http://schuremed.com/videos)



### Complete Shoulder System

Includes the Schure Loc™ XPS, Disposable Head & Chin Straps, Multi-Axis Arm Positioner, Schure Socket XL, Disposable Schure Loc™ XPS Sterile Kit and Shoulder Chair Dolly.

#### Complete Shoulder System w/Schure Loc™ XPS

Choose Preferred Beach Chair:

**#800-0293** With Powered Beach Chair

**#800-0294 & #800-0294-EU** With E-Z Lift Beach Chair

Watch VIDEO  
[schuremed.com/videos](http://schuremed.com/videos)

## E-Z Lift Beach Chair



## SHOULDER SURGERY

### E-Z Lift Beach Chair

- Reduces effort when lifting patients compared to manual systems
- Double-ball joint head system safely secures patient's head

The E-Z Lift Beach Chair provides a lightweight and cost-effective option to our fully powered shoulder chair.

Double ball joint head system allows complete control of the patient's head with one knob. Using multiple articulating joints allow the head positioner to safely and effectively control the most challenging patient anatomies, even super kyphosis patients.

This system employs a powerful piston to lift the patient. Adjusts to fit any OR table with our integrated adjustable mounting clamps. 500 lb. (227 kg) patient weight capacity. Articulation range is 0°–90°. Lateral Brace included.

**#800-0142** E-Z Lift Beach Chair

**#800-0142-EU** E-Z Lift Beach Chair, EU

*Required Accessories: Select One Model*

**#800-0164** Disposable Face Masks, 12/cs\*

**#800-0369** Premium Head & Chin Straps, 12/cs\*

*\*Products are non-returnable.*

*Optional Accessories*

**#800-0074** Shoulder Chair Dolly

**#800-0050** Multi-Axis Arm Positioner

**#800-0134** Schure Socket XL

**#800-0134-EU** Schure Socket XL



Premium Head & Chin Straps

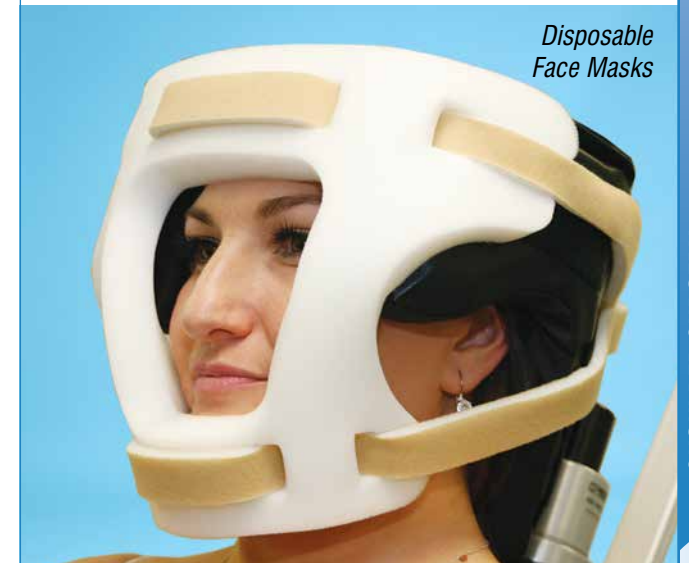

Disposable Face Masks



Schure Socket XL



Shoulder Chair Dolly



Multi-Axis Arm Positioner

500 lb. (227 kg)  
Patient Wt. Capacity

# SHOULDER SURGERY



### Easy as 1, 2, 3

- Squeeze and hold lever to release all six device joints
- Position limb in exact position
- Release lever to securely lock into position

 Watch VIDEO  
[schuremed.com/videos](http://schuremed.com/videos)

### Schure Loc™ XPS Optional Accessories



Forearm Attachment

Counter Traction Post



TKR Positioner

Elbow/Ankle Positioner



Adapter

Armboard

**NEW**  
Clamp fits ALL  
global OR table  
side rails

3602  
UltraSlide SKYTRON

Patent Pending

## Schure Loc™ XPS

- Securely and safely holds patient arm in any desired position during arthroscopic surgery
- Compact and lightweight
- No foot pedals, hoses, hydraulics or power cords
- Ships assembled and ready for immediate use
- Single lever releases all joints for positioning and relocks when released
- Decreases surgeon fatigue and improves intraoperative control of surgical limb
- Schure Loc™ XPS reduces staffing needs providing a more cost-effective procedure
- Schure Loc™ XPS Shoulder Kit conveniently includes a sterile drape, foam hand/forearm holder and self-adherent wrap
- New clamp fits all global OR table side rails

Schure Loc™ XPS currently outperforms similar equipment for shoulder surgery in both beach chair and lateral positions. The Schure Loc™ XPS is the perfect companion piece for any beach chair positioner—easily attaching to any OR table rail while freeing your surgical assistant to do much more than steady the patient's limb. Get the most from your team by adding this high-quality, easy-to-use device to your shoulder surgery equipment.

**#800-0280** Schure Loc™ XPS

#### Optional Accessories

**#800-0281** Schure Loc™ XPS Sterile Kit, 10/cs\*  
Includes Sterile Forearm Wrap, Sterile Self-Adherent Coban™ and Sterile Drape (fits whole arm).  
\*Sterile products are non-returnable.

**#790-0039** Schure Loc™ XPS Adapter

**#790-0040** Schure Loc™ XPS Forearm Attachment

**#790-0056** Schure Loc™ XPS Armboard

**#790-0057** Schure Loc™ XPS Counter Traction Post

**#790-0075** Schure Loc™ XPS Elbow/Ankle Positioner

**#790-0077** Schure Loc™ XPS TKR Positioner



Provides excellent positioning and surgical access for beach chair, lateral shoulder and supine elbow procedures.

# TKR for Total Knee Replacement

**NEW  
Improved  
Design**

Watch VIDEO  
[schuremed.com/videos](http://schuremed.com/videos)

#800-0141 24"



**NEW!**

Custom Sterilization Tray Included

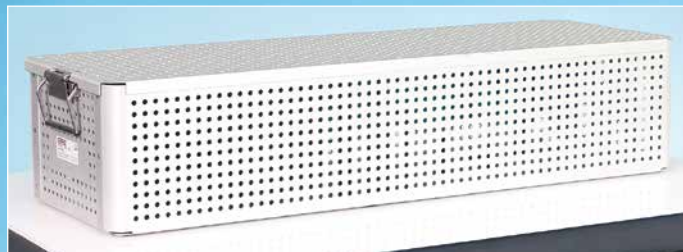

## TKR Positioner for Total Knee Replacement

- Track Locking Bracket securely locks the Base Plate to the table with two thumb screws
- Locks in any position with a simple turn of the wrist
- Smooth sliding motion for effortless leg positioning
- Well leg lies flat – eliminating the need for well-leg positioners, sandbags and gel pads
- Easy-to-use and completely rigid once locked
- All components are autoclavable
- CamLoc Rail Clamp sold separately (see below)

Ball joint allows the surgeon to position the operative leg in extension, flexion, tilt and rotation.

- #800-0141 TKR Positioner, 24" (61 cm)
- #800-0171 TKR Positioner, 30" (76 cm)
- #800-0146 TKR Boot Liners, Sterile, 12/cs\*
- \*Sterile products are non-returnable.

- CamLoc Rail Clamp - Required Accessory - Choose One
- #800-0271 (Use with 1-2 drapes)
  - #800-0271-L (Use with 3-5 drapes)
  - #800-0271-UK #800-0271-DEN #800-0271-EU
  - #800-0271-JPN #800-0271-SWISS



#800-0171 30"





Stainless Steel

### SchureFoot for Total Knee Replacement

- This new design offers the same secure support as the stainless steel model without the concerns of radiopacity
- The surgeon can replace the knee while the patient's foot is held firmly in place
- Disposable conductive, non-latex foot pad included
- Now available in radiolucent, clear Lexan®
- Patient's well leg lies flat
- Schure Socket XL sold separately
- Lexan: 12"L x 16"H x 2"D (31 cm x 41 cm x 5 cm)
- Stainless Steel: 12"L x 18"H x 2"D (31 cm x 46 cm x 5 cm)

- #800-0011 SchureFoot, Lexan
- #800-0062 SchureFoot, Stainless Steel

- Required Accessory  
#800-0134 Schure Socket XL

- Replacement Pads  
#508-0111 SchureFoot Disposable Pads, 12/cs\*  
\*Product is non-returnable.



Lexan

### Arthroscopic Leg Holder

- Hook and loop fastener strap wraps completely over leg holder for total stability
- Pressure relief foam pad included
- 5/8" (1.6 cm) mounting post
- Schure Socket XL sold separately

Extremely versatile, easy-to-use and completely rigid. Spring-loaded braces slide into place and snap lock.

- #800-0023 Arthroscopic Leg Holder

- Required Accessory  
#800-0134 Schure Socket XL

- Optional Accessory  
#508-0352 Well Leg Holder

- Replacement Pads  
#508-0103 Disposable Premium Pads, 12/cs\*  
\*Product is non-returnable.



### Schure Grip Leg Holder

- Dual independent braces freely rotate 360° and spread horizontally from 3"-11"W (8 cm-28 cm) to fit any size leg at any angle
- Twist one brace side down, put the patient's leg on the leg holder, return the brace side back up, slide brace horizontally for a snug fit, and lock in place with convenient twist handle

Use also for ACL procedures. Stainless steel. 12"L x 1.5"D (31 cm x 4 cm) leg support x 8"H (20 cm) braces, 16"H x 5/8"D (41 cm x 1.6 cm) mounting post. Schure Socket XL sold separately.

- #800-0065 Schure Grip Leg Holder

- Required Accessory  
#800-0134 Schure Socket XL

- Replacement Pads  
#508-0103 Disposable Premium Pads, 12/cs\*  
\*Product is non-returnable.



KNEE SURGERY

KNEE SURGERY

# SPINAL SURGERY

# PATIENT POSITIONING

Watch VIDEO  
[schuremed.com/videos](http://schuremed.com/videos)

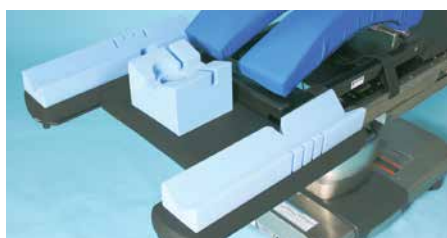

## Schure Spine Frame

- Adjusts intraoperatively to the desired lordosis to get optimal surgical site exposure
- Transport dolly of durable stainless steel included
- Patient weight capacity is 500 lbs. (227 kg)
- Deluxe foam pads included

The Schure Spine Frame provides a stable and convenient platform for spine surgeries such as laminectomies, decompressions, and disc surgery. You can adjust it intraoperatively to the desired lordosis to get optimal surgical site exposure. Tapered adjustable pads provide optimal patient safety and comfort. The Schure Spine Frame has a patient weight capacity of 500 lbs. (227 kg) and is C-arm compatible. It can be used with any

OR table, and fits the Jackson Spine Table and Allen Flex Frame as well. Comes complete with transport storage dolly (retail customers only) and crank handle, disposable head rest, and two arm cradles.

**#800-0235** Schure Spine Frame

### Optional Accessories

- #508-0373** Disposable Laminectomy Arm Cradles, 12 prs/cs
- #508-1340** Disposable Richard Slotted Head Rests, Extended, 6/cs
- #800-0074-SF** Schure Spine Frame Dolly

### Replacement Products

- #508-0472** Schure Spine Frame Pad Set
- #800-0277** Schure Spine Frame Crank Handle

## Surgical Peg Board System

### Includes:

- Four 6" (15 cm)/Four 9" (23 cm) covered short pegs, Two Fixation Clamps, Gel Overlay item #508-0440 & Peg Board 48"L x 19"W x 1" thick (122 cm x 48 cm x 3 cm)
- Requires (2) #800-0338 to secure Peg Board to OR table

**#800-0354** Surgical Peg Board System

Required SpringLoc Clamp: Purchase Two

**#800-0338**                    **#800-0338-JPN**

**#800-0338-EU**                **#800-0338-SWISS**

### Replacement Parts

**#800-0354-A** 6" Removable Pegs, Plastic, Set of Four

**#800-0354-B** 9" Removable Pegs, Plastic, Set of Four



**#800-0354-B** 9" Removable Pegs, Plastic, Set of Four

**#800-0354-C** Fixation Clamps, Set of Two

**#800-0354-D** Peg Board/Posting Board

**#800-0354-E** 6" Removable Pegs, Stainless Steel, Set of Four

**#800-0354-F** 9" Removable Pegs, Stainless Steel, Set of Four

**#508-0440** Gel Overlay, 20" x 46" x .5" (51 cm x 117 cm x 1.3 cm)

**#800-0354-G** Gel Overlay, 24" x 50" x .5" (61 cm x 127 cm x 1.3 cm)

**#800-0354-H** 4" (10 cm) Peg Extension, ea

## Lateral Positioners

- Lateral Positioners are simple to set up and offer another alternative for lateral positioning
- Three swivel braces have Deluxe foam pads and rotate over the OR to conform to any size patient, they offer complete stability and ease of use
- 5/8" (1.6 cm) stainless steel mounting posts

**#800-0043** Lateral Positioners

Required Accessory: Purchase 3 - sold separately

**#800-0134** Schure Socket XL

### Replacement Pad

**#508-0156** Lateral Positioner Pad



Note: Multi-Axis Arm Positioner, Standard Armboard, Coated Adult Head Support Pad and clamps sold separately.

## Lateral Braces

- Secure and comfortable positioning for total hip replacement, and any other procedure requiring total lateral stability
- Three multi-axis braces easily accommodate any size patient for perfect lateral positioning
- Pressure relief foam with Deluxe cover provide extreme protection for the patient

**#800-0042** Lateral Braces

Required Accessory: Purchase 3 - sold separately

**#800-0134** Schure Socket XL

### Replacement Pads

**#508-0115** Round Lateral Brace Pad

**#508-0116** Rectangle Lateral Brace Pad



Note: Multi-Axis Arm Positioner, Standard Armboard, Coated Adult Head Support Pad and clamps sold separately.

SPINAL SURGERY

PATIENT POSITIONING

## TABLE CLAMPS

## TABLE CLAMPS

Watch VIDEO  
[schuremed.com/videos](http://schuremed.com/videos)



800 lb. (363 kg)  
Patient Wt. Capacity

Patented

### Schure Socket XL

- Hardened clamping surface creates maximum clamping force stopping movement of all accessories
- Attaches along side rail, without the need of notches

Accepts any round mounting posts up to 5/8"D (1.6 cm) and rectangular mounting posts up to 1" x 3/8" (2.5 cm x .95 cm). Quickly and easily connects and disconnects securely with a quick turn anywhere along the side rail, even over side rail stand off.

**Schure Socket XL**  
**#800-0134**      **#800-0134-SWISS**  
**#800-0134-EU**      **#800-0134-DEN**  
**#800-0134-JPN**      **#800-0134-UK**

### Schure Socket

- Fits round mounting posts up to 5/8"D (1.6 cm)
- Locks securely with a twist of the ergonomic handle
- Attaches along side rail, without the need of notches

Industrial strength Schure Socket fits all OR tables with standard 3/8"W x 1 1/8"H (.95 cm x 2.85 cm) side rails.

**Schure Socket**  
**#800-0006**      **#800-0006-SWISS**      **#800-0006-EU**  
**#800-0006-DEN**      **#800-0006-JPN**      **#800-0006-UK**



800 lb. (363 kg)  
Patient Wt. Capacity

Patented

### Universal Rail Clamp

- Spring-loaded and attaches to OR table side rail anywhere along the rail
- Accessories can be mounted vertically or horizontally
- Locks securely with a twist of the ergonomic handle

Accepts both 5/8"D (1.6 cm) and 1" x 3/8" (2.5 cm x .95 cm) flat bar mounting posts.

**#800-0085** Universal Rail Clamp



350 lb. (159 kg)  
Patient Wt. Capacity

Patented

### Simple Clamp

- Attaches at OR table rail ends or notches
- Accessories can be mounted vertically or horizontally

Securely locks all accessories with flat 1" x 3/8" (2.5 cm x .95 cm) vertically mounting blades anywhere along table side rail. 1" x .25" (2.5 cm x .64 cm) horizontally mounting blades.

**#800-0228**      **#800-0228-UK**      **#800-0228-SWISS**  
**#800-0228-EU**      **#800-0228-JPN**      **#800-0228-DEN**

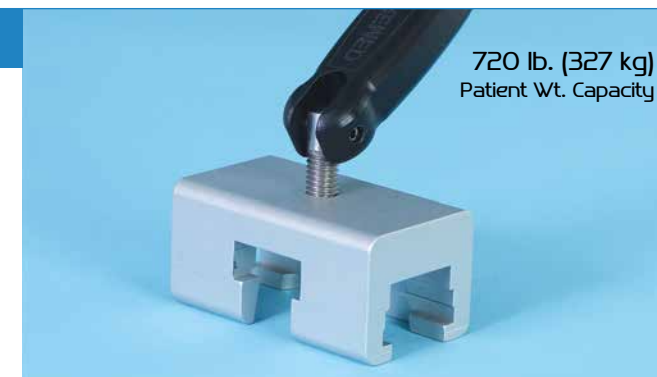

720 lb. (327 kg)  
Patient Wt. Capacity

### Deluxe Rail Clamp

- Attaches at OR table rail ends or notches
- Accessories can be mounted vertically or horizontally

Securely locks all accessories with 1" x 3/8" (2.5 cm x .95 cm) flat mounting post and round mounting posts up to 5/8"D (1.6 cm) mounting blades anywhere along table side rail.

**#800-0248**      **#800-0248-SWISS**      **#800-0248-EU**  
**#800-0248-JPN**      **#800-0248-DEN**      **#800-0248-UK**

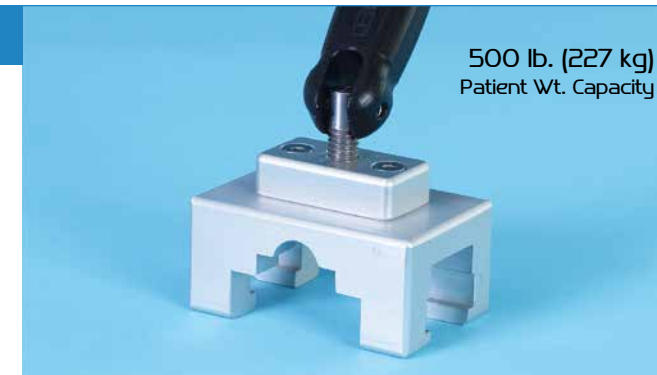

500 lb. (227 kg)  
Patient Wt. Capacity

### SpringLoc Clamp

- Securely locks accessories with a flat 1" x .25" (2.5 cm x .6 cm) mounting post
- Attaches along side rail, without the need of notches
- Quick & easy pull-to-release lever

**SpringLoc Clamp**  
**#800-0338**      **#800-0338-JPN**  
**#800-0338-EU**      **#800-0338-SWISS**



1,000 lb. (454 kg)  
Patient Wt. Capacity

### CamLoc Rail Clamp

- It can attach to the rail at any location over 1-2 drapes and accepts accessories with round posts up to 5/8"D (1.6 cm) and flat posts 1" x 3/8" (2.5 cm x .95 cm)
- Attaches along side rail, without the need of notches

The CamLoc Rail Clamp is designed for use in the sterile field. Choose Standard Clamp to use with 1-2 drapes or Large Clamp for 3-5 drapes.

**CamLoc Rail Clamp**  
**#800-0271** (Use with 1-2 Drapes)  
**#800-0271-L** Large (Use with 3-5 Drapes)  
**#800-0271-UK**      **#800-0271-DEN**      **#800-0271-JPN**  
**#800-0271-EU**      **#800-0271-SWISS**



500 lb. (227 kg)  
Patient Wt. Capacity

## TABLE EXTENSIONS

## TABLE EXTENSIONS



### Adjustable Footboard/Table Extension

- Mounts horizontally as a table extension & vertically as a foot support when using reverse Trendelenburg
- Simply pull on both locking knobs to adjust position
- Includes a 2" (5 cm) Pressure Management Pad
- 24"W x 10"L (61 cm x 25 cm)

#800-0285 Adjustable Footboard/Table Extension

Required Accessory: Purchase Two

**SpringLoc Clamp**  
 #800-0338 #800-0338-EU #800-0338-JPN  
 #800-0338 #800-0338-UK #800-0338-SWISS

Replacement Pad  
 #508-1347 Adjustable Foot Board/Table Extension Pad

### Bariatric Foot Extension, 36 x 18

- Mounts vertically as a foot support when using reverse Trendelenburg
- Fits all OR tables

Use as a table extension in the horizontal position to lengthen size of OR table. 2" (5 cm) Deluxe Pad included.

#800-0326 Bariatric Foot Extension, 36"W x 18"L (91 cm x 46 cm)  
 Required Simple Clamp: Order Two  
 #800-0228 #800-0228-UK #800-0228-SWISS  
 #800-0228-EU #800-0228-DEN #800-0228-JPN

Replacement Pad  
 #508-1371 Bariatric Foot Extension Pad



### Table Width Extensions

- Attaches to OR side rail with mounting clamp
- Raise or lower height of extender to be level with the OR table, either with or without an x-ray top

Attached side rail allows any table accessory to be mounted. Deluxe pad included.

#800-0077 20"L x 4"W (51 cm x 10 cm)  
 #800-0079 15"L x 8"W (38 cm x 20 cm)  
 #800-0081 11"L x 8"W (28 cm x 20 cm)  
 Required Simple Clamp: Order One  
 #800-0228 #800-0228-UK #800-0228-SWISS  
 #800-0228-EU #800-0228-DEN #800-0228-JPN

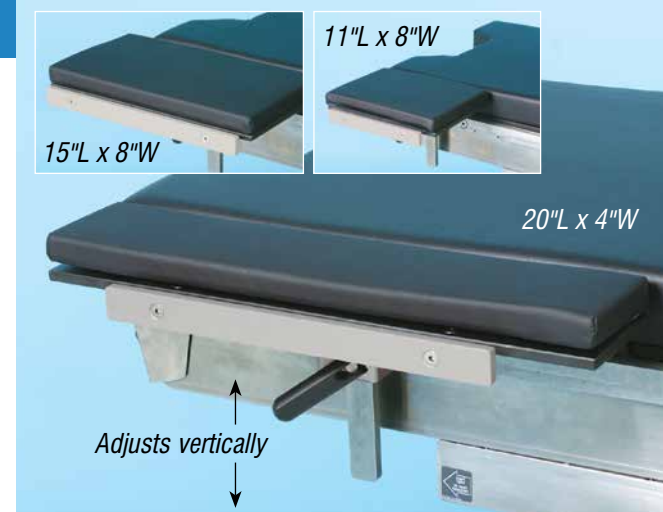

TABLE EXTENSIONS



### Foot Extension, 20 x 10

- Mounts vertically as a foot support when using reverse Trendelenburg
- Fits all OR tables
- 20"W x 10"L (51 cm x 25 cm)

Use as a table extension in the horizontal position to lengthen size of OR table. 2" (5 cm) Deluxe Pad included.

#800-0036 Foot Extension, 20 x 10  
 Required Simple Clamp: Order Two  
 #800-0228 #800-0228-UK #800-0228-SWISS  
 #800-0228-EU #800-0228-DEN #800-0228-JPN  
 Replacement Pad  
 #508-0090 Foot Extension Pad



### Narrow Headrest

- Improves surgeon's access at the head of the surgical table during ENT, neurosurgery, plastic surgery or ophthalmic surgery. Use instead of standard headrest.
- Radiolucent headrest includes 2" (5 cm) premium pressure management pad. Deluxe pad included.

#800-0052 Narrow Headrest  
 Required Simple Clamp: Order Two  
 #800-0228 #800-0228-UK #800-0228-SWISS  
 #800-0228-EU #800-0228-DEN #800-0228-JPN  
 Optional Accessory  
 #800-0086 Wrist Rest  
 Replacement Pad  
 #508-0109 Narrow Headrest Pad

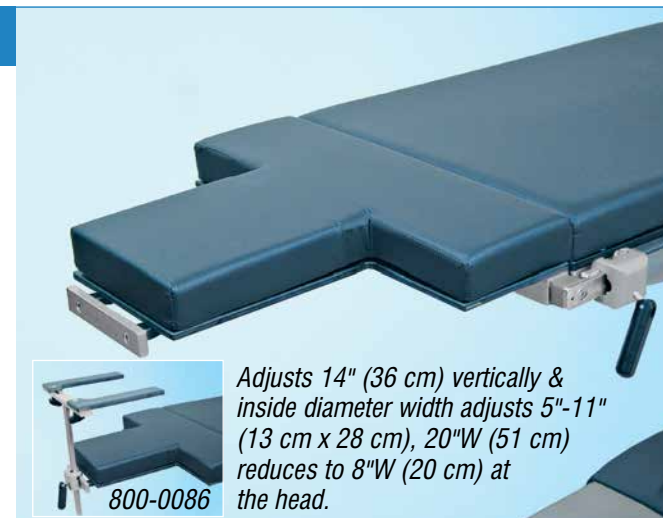

TABLE EXTENSIONS





### Standard Armboard

- Simply place armboard on OR table side rail and it snaps locked tight, 6"W x 26.5"L (15 cm x 67 cm)
- Armboard offers a full range of motion, swings 180°
- Simply pull finger trigger at end of armboard and move to required position. Release trigger and it locks tight. To remove, just pull finger trigger and lift off side rail.

#800-0008 #800-0008-DEN #800-0008-EU  
#800-0008-UK #800-0008-JPN

Required Pad: Choose One

#508-0071 Deluxe Armboard Pad  
#508-0151 Softcare Armboard Pad

Pad sold separately

Watch VIDEO  
[schuremed.com/videos](http://schuremed.com/videos)

### Radiolucent Armboard

- Slips under patient's shoulder and provides support during injection of contrast materials for MRI and CT scans or placement of PICC lines
- 2" (5 cm) Conductive Vinyl Covered Foam Pad sold separately: Deluxe or Softcare
- Pad attaches to armboard with hook and loop fastener
- Radiolucent, Phenolic and Reusable

#800-0297 Radiolucent Armboard,  
6"W x 36"L (15 cm x 91 cm)

Required Pad: Choose One

#508-0071 Deluxe Armboard Pad  
#508-0151 Softcare Armboard Pad

Pad sold separately



### Adjustable Height Armboard

- This armboard adjusts vertically, up to 2.5" (6 cm), to be level with OR table, either with or without X-ray tops
- To adjust armboard vertically, simply place armboard on side rail, loosen handle and raise to correct table height and tighten handle
- 6"W x 26.5"L (15 cm x 67 cm)
- Eliminates multiple size pads

#800-0009 #800-0009-UK #800-0009-JPN  
#800-0009-EU #800-0009-DEN

Required Pad: Choose One

#508-0071 Deluxe Armboard Pad  
#508-0151 Softcare Armboard Pad

Pad sold separately

### Incline Armboard Pad

- Prevents hyperextension of the forearm
- Fits all 6"W x 26"L (15 cm x 66 cm) armboards
- Made with pressure-diffusing T-Foam™
- Covered in durable, black, conductive vinyl

#508-1355 Incline Armboard Pad



### X-Wide & X-Wide Adj. Ht. Armboards

#### Extra-Wide Armboard

- 11"W x 26.5"L (28 cm x 67 cm) to offer a bigger surface area when necessary

#800-0018 #800-0018-UK  
#800-0018-EU #800-0018-DEN

#### Extra-Wide, Adjustable Height Armboard

- This armboard adjusts vertically to be level with OR table, either with or without X-ray tops

#800-0017 #800-0017-UK  
#800-0017-EU #800-0017-DEN

Required Pad: Choose One

#508-0105 Deluxe Extra-Wide Armboard Pad  
#508-0152 Softcare Extra-Wide Armboard Pad

Pad sold separately

### Armboard Wall Rack

- Stores two standard surgical table armboards
- Use convenient top shelf for clamps or other accessories
- Attaches to wall with four screws & two wall anchors (supplied)

#800-0296 Armboard Wall Rack



ARMBOARDS

ARMBOARDS



## SURGICAL ARM SUPPORTS

### Lateral Arm Support

- Articulated arms with quick central fixation for secure arm positioning during surgical interventions.
- Rapid locking base allows connection to the side rails of the OR table
- Supplied with clamp that fits US and Euro rails
- Armboard 17.7" L (45 cm)
- Uncompromising, efficient handling and safe holding
- Lateral Articulated Arm is 18.11"L (46 cm)
- Space saving on the OR table, compact design
- Anatomically shaped visco-elastic (VE) – pad
- One step set up

**#811-0001** Lateral Arm Support



**NEW!**

The mechanical central tightening device enables simple and secure holding of the patient's arm during anesthesia.



### Multi-Axis Arm Positioner



- Versatile and comfortable positioning with the new ball socket locking system
- Arm platform measures 6"W x 16"L (15 cm x 41 cm)
- 2" (5 cm) Deluxe Concave Foam Pad included
- 5/8" (1.6 cm) Mounting Post

Perfect for seated, lateral, prone, neuro and park bench positions. Schure Socket XL sold separately.

**#800-0050** Multi-Axis Arm Positioner

*Required Accessory*

**#800-0134** Schure Socket XL

*Replacement Pad*

**#508-0108** Concave Deluxe Multi-Axis Arm Positioner Pad, 16" x 6" x 2" (41 cm x 15 cm x 5 cm)



## PROCEDURE HAND TABLES



### Choose Carbon Fiber or Phenolic

- Carbon fiber technology produces incredibly solid components that are completely invisible to x-rays
- End rail accommodates traction attachment and locks to side rail in seconds

- Major, End Rest & Hourglass Tables have an adjustable leg & twist handle locking system which adjusts up or down to be level with surgical table
- Deluxe 1" (3 cm) Foam Pad included

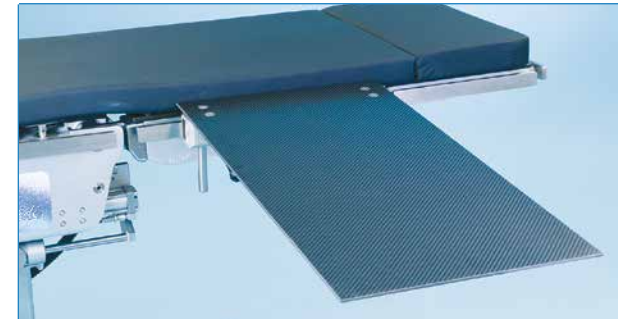

### Minor Procedure Table

Table measures 15"W x 30"L (38 cm x 76 cm).

#### Minor Procedure Table

**#800-0026-MI-CF** Carbon Fiber

**#800-0026-MI-P** Phenolic

*Replacement Pad*

**#508-1432** Minor Procedure Table Deluxe Pad



### Hourglass Procedure Table w/Leg

Table measures 15"W (38 cm) at middle and 32"L x 23"W (81 cm x 58 cm) at table ends.

#### Hourglass Procedure Table w/Leg

**#800-0026-HG-CF** Carbon Fiber

**#800-0026-HG-P** Phenolic

*Replacement Pad*

**#508-0106** Hourglass Procedure Table Deluxe Pad

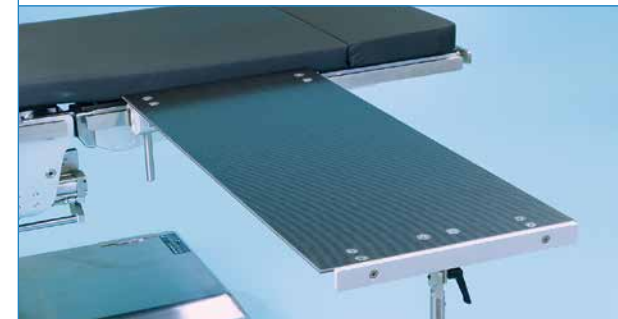

### Major Procedure Table w/Leg

Table measures 15"W x 34"L (38 cm x 86 cm).

#### Major Procedure Table w/Leg

**#800-0026-MJ-CF** Carbon Fiber

**#800-0026-MJ-P** Phenolic

*Replacement Pad*

**#508-0073** Major Procedure Table Deluxe Pad



### End Rest Procedure Table w/Leg

Table measures 16"W (41 cm) at narrow end & 34"L x 26" (86 cm x 66 cm) at wider end.

#### End Rest Procedure Table w/Leg

**#800-0026-ER-CF** Carbon Fiber

**#800-0026-ER-P** Phenolic

*Replacement Pad*

**#508-0101** End Rest Procedure Table Deluxe Pad

*Two Clamps Required*

**Universal Clamp, US: #800-0085**

**Deluxe Rail Clamp: #800-0248-EU, #800-0248-UK, #800-0248-DEN, #800-0248-SWISS, #800-0248-JPN**

 LEG PREPPERS

SURGICAL TABLE ACCESSORIES 



**Bi-Lateral Leg Prepper**

- 500 lb. (227 kg) patient weight capacity
- Schure Socket XL sold separately

The Bi-Lateral Leg Prepper safely and effectively holds both legs for bi-lateral preps. The unique rotating/pivoting design of the holders allow for infinite positioning of the extremity. Includes 2" (5 cm) Deluxe Pads.

**#800-0236** Bi-Lateral Leg Prepper

*Required Accessory*

**#800-0134** Schure Socket XL

*Replacement Pad (sold individually)*

**#508-0159** Universal Prepper Pad



**Universal Prepper**

- Supports limbs of all sizes - 31"L x 9"W x 2"H (79 cm x 23 cm x 5 cm)
- Pad removes for easy cleaning

Universal Prepper safely and effectively holds upper or lower extremities. The unique pivoting design allows for infinite positioning of the extremity. Comes complete with 2" (5 cm) thick Deluxe pad.

**#800-0161** Universal Prepper

*Required Accessory (sold separately)*

**#800-0134** Schure Socket XL

*Replacement Pad*

**#508-0159** Universal Prepper Pad



**Leg Prepper**

- Padded horseshoe cradle holds patient's leg comfortably during the prepping procedure
- Stainless steel 30"H x 5/8"D (76 cm x 1.6 cm) mounting post rotates, rises, and lowers easily to various prepping positions
- Schure Socket XL sold separately

**#800-0013** Leg Prepper

*Required Accessory*

**#800-0134** Schure Socket XL

*Replacement Pad*

**#790-0074** Leg Prepper Pad & Cover

**Premium Head & Chin Straps**

Premium Head & Chin Strap Positioners hold head securely during the operative procedure. Hook & loop fasteners are soft and pliable and attach to head frame.

**#800-0369** Premium Head & Chin Straps, 12/cs\*

*\*Product is non-returnable.*



**Disposable Face Masks**

Disposable Face Masks hold head securely in proper patient position during surgical procedures. Hook & loop brand fasteners are soft and pliable and attach easily to the head frame.

**#800-0164** Disposable Face Masks, 12/cs\*

*\*Product is non-returnable.*



**Schure Strap Brand Rolls**

Schure Strap is the answer to your taping, strapping, tie-down and restraining requirements. It has a hook and loop fastener on 30' (9 meters) rolls and is available in 4 widths. No sticky tape residue to damage equipment. Soft edge design to protect patient's skin.

*Not made with natural rubber latex.*

**#800-0147** .75"W (2 cm)

**#800-0148** 1.5"W (4 cm)

**#800-0149** 3"W (8 cm)

**#800-0150** 5"W (13 cm)



LEG PREPPERS

SURGICAL TABLE ACCESSORIES

## SURGICAL TABLE ACCESSORIES

## SURGICAL TABLE ACCESSORIES



### Toboggan Arm/Leg Guards

- Available in four sizes: Small through X-Large
- Simply slide under OR table pad to secure arms or legs
- Physician can lean against guards without interfering with anesthesia lines

- #800-0084 Sm., 6"H x 10"L (15 cm x 25 cm)
- #800-0083 Med., 8"H x 16"L (20 cm x 41 cm)
- #800-0082 Lg., 10.5"H x 16"L (27 cm x 41 cm)
- #800-0276 X-Lg., 10.5"H x 24"L (27 cm x 61 cm)

#### Optional Pad Accessories

- #508-0155 Toboggan Pad, Small
- #508-0145 Toboggan Pad, Medium
- #508-0144 Toboggan Pad, Large
- #508-1399 Toboggan Pad, X-Large

### Comfort Mat

The 20" x 33" (51 cm x 84 cm) Comfort Mat is ideal at scrub sinks, nurse's stations or at OR tables. Helps reduce fatigue, pain and discomfort associated with standing for long periods of time.

- Absorbent-resistant closed-cell foam
- Non-slip surface is chemical resistant
- Beveled, low-profile edges
- Custom sizes are available
- Made in USA

- #800-0145 Comfort Mat



### Anesthesia Screen

- Adjusts from 15"-33" (38 cm x 84 cm) in height
- Horizontal adjustment feature facilitates viewing of patient
- Locks with a .25" (.6 cm) twist of the handle
- Stainless steel construction
- Schure Socket XL sold separately

- #800-0016 Anesthesia Screen

#### Required Accessory

- #800-0134 Schure Socket XL

### Safety Draw

- Avoid needle sticks
- Hands-free access to medication vials
- Easy viewing of medication labels
- Helps reduce medication errors

Safety-Draw maintains sterility while allowing access to non-sterile vials. This protects both patient and staff by helping to prevent dangerous medication mix-up, as well as needle sticks.

- #800-0059 Safety Draw, IV Pole Mount
- #800-0060 Safety Draw, Mayo Stand Mount



### Elbow Arthroscopy Support

The Elbow Arthroscopy Support comfortably and securely holds the upper extremity for prepping and during surgical procedures. Comes complete with 2" (5 cm) Deluxe pad which can be removed for easy cleaning. Schure Socket XL sold separately.

- #800-0168 Elbow Arthroscopy Support

#### Required Accessory

- #800-0134 Schure Socket XL

#### Replacement Pad

- #508-0159 Universal Prepper Pad

### Wrist Tower

- Simply dial in your tension...eliminates use of sand bags
- All components are autoclavable
- Eliminates the need for assistant to hold extremity

- #800-0135 Wrist Tower

#### Required CamLoc Rail Clamp: Order One

- #800-0271 (Use with 1-2 drapes) #800-0271-EU
- #800-0271-L (Use with 3-5 drapes) #800-0271-JPN
- #800-0271-SWISS #800-0271-DEN #800-0271-UK

#### Required Accessory

- #512-0015 Finger Traps, Limited Reuse

Please call customer service for pricing & specifications.

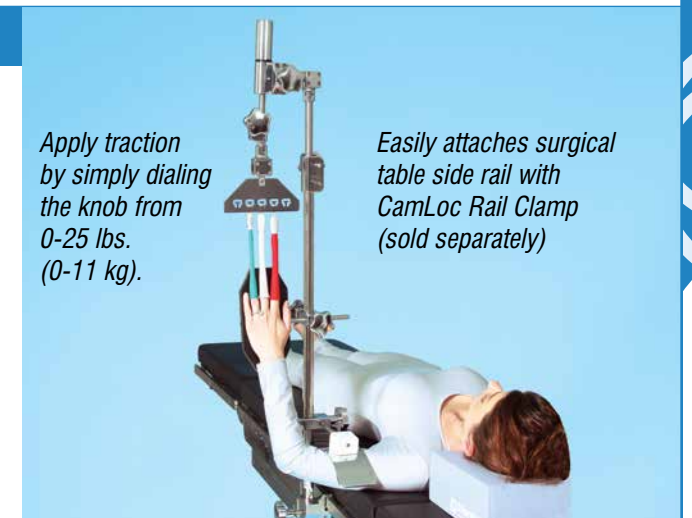

Apply traction by simply dialing the knob from 0-25 lbs. (0-11 kg).

Easily attaches surgical table side rail with CamLoc Rail Clamp (sold separately)



## SURGICAL TABLE ACCESSORIES

## SURGICAL TABLE ACCESSORIES



### Nissen Straps

- Offers support needed during steep reverse Trendelenburg positioning. Attaches to rail quickly and securely.
- 20"L x 5"W x 1" (51 cm x 13 cm x 3 cm) thick pad offers complete support

**#800-0055** Nissen Straps, 48"L x 2"W (122 cm x 5 cm)

**#800-0118** Bariatric Nissen Straps, 72"L x 2"W (183 cm x 5 cm)

Required Simple Clamp: Order Two

**#800-0228**    **#800-0228-UK**    **#800-0228-SWISS**  
**#800-0228-EU**    **#800-0228-DEN**    **#800-0228-JPN**

### Well Leg Holder

- Helps prevent nerve damage
- 31"L x 9"W x 2"H (79 cm x 23 cm x 5 cm)
- Works on both left and right leg

The foam Well-Leg Holder easily supports with comfort the non-affected, well-leg during arthroscopic knee procedures, fracture repairs and cast procedures.

**#508-0352** Well Leg Holder



**#800-0057**

**#800-0119**

### Restraint Straps

- Amsco style
- All-rubber conductive strap
- Choose 96"L (244 cm) or 139"L (353 cm) Bariatric version
- Very durable...easy to clean and disinfect
- Mounts to surgical table with or without hooks

**#800-0057** Restraint Strap, 96"L (244 cm)

**#800-0119** Bariatric Restraint Strap with Pad, 139"L (353 cm)

Required Accessory

**#512-0039** Restraint Strap Mounting Hook

### Extremity Positioner

- Great for positioning the lower extremity for foot or ankle procedures
- Sealed seams for easy clean-up
- 16"L x 12"W x 7"H (41 cm x 30 cm x 18 cm)

This pad is ideal and used regularly for prepping of the arm or leg surgical site.

**#508-0353** Extremity Positioner



**#800-0143**

### Disposable A-Line Positioners

A-Line Positioners are a disposable support positioner to provide for a fast, consistent and reliable A-Line insertion.

A-Line Positioner w/Straps consist of two exclusive 1"W x 17"L (3 cm x 43 cm) soft edge straps which reduce the risk against skin ulceration. This anatomically formed base provides the best angle while keeping the skin taut for optimal needle insertion.

**#800-0144** Disp. A-Line Positioners, 30/cs

**#800-0143** Disp. A-Line Positioner w/Straps, 12/cs

### Saphenous Vein Harvest Pad

- Holds legs externally rotated and slightly flexed for minimally invasive, bridging or open harvesting procedures
- The cover is a multi-directional stretch cover. Inside consists of a top layer of conforming foam with a firm supportive base. Water-resistant cover is not made with natural rubber latex.
- Sealed watertight seams for easy clean-up
- 32"L x 20.5"W x 6.5"H (81 cm x 52 cm x 17 cm)

The Saphenous Vein Harvest Pad holds patient's legs at the optimal position for assessment and harvesting of the saphenous veins for coronary bypass surgery.

**#508-0385** Saphenous Vein Harvest Pad



**COATED POSITIONING PADS**

**DISPOSABLE POSITIONING PADS**

Reduces Chance of  
Cross-Contamination  
Slip-Resistant

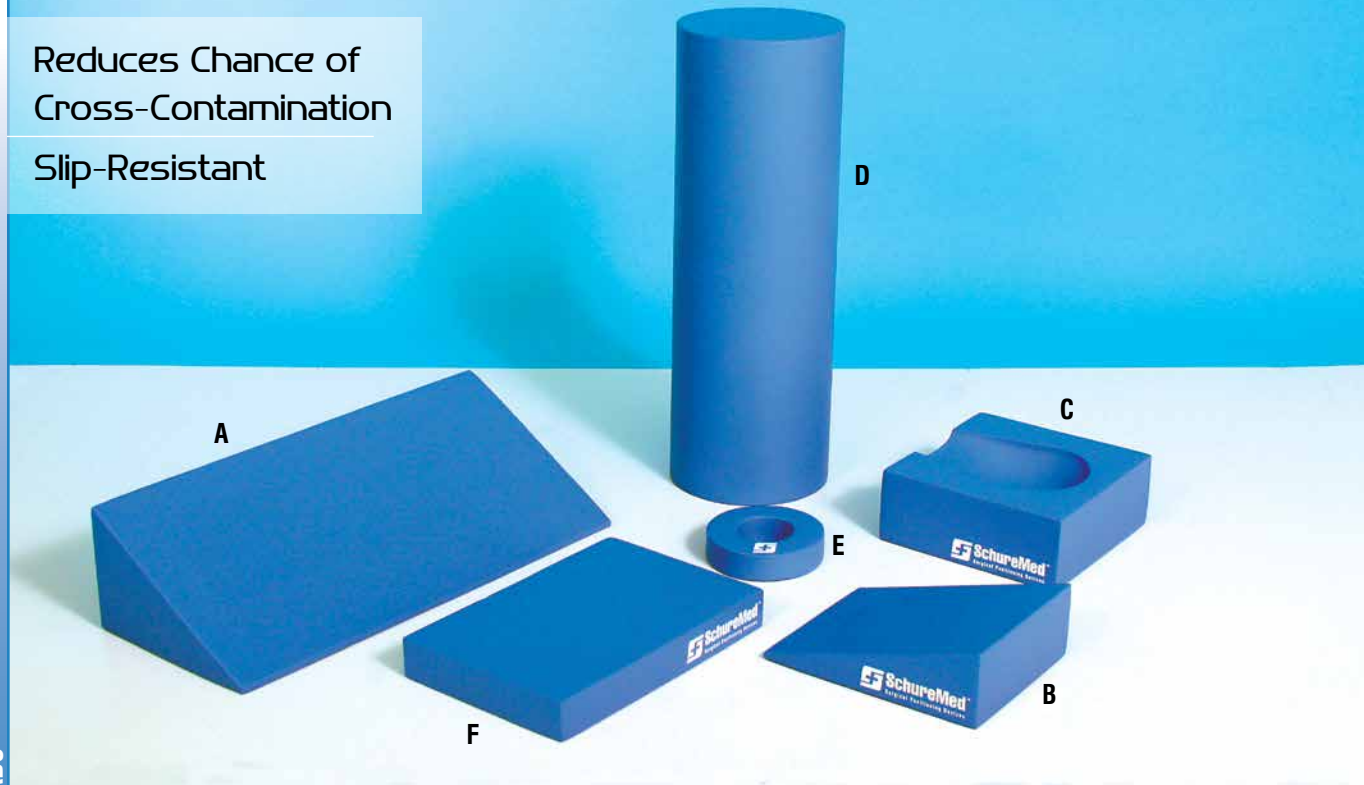

Variety of Shapes  
& Sizes Available  
High-Density  
Polyfoam

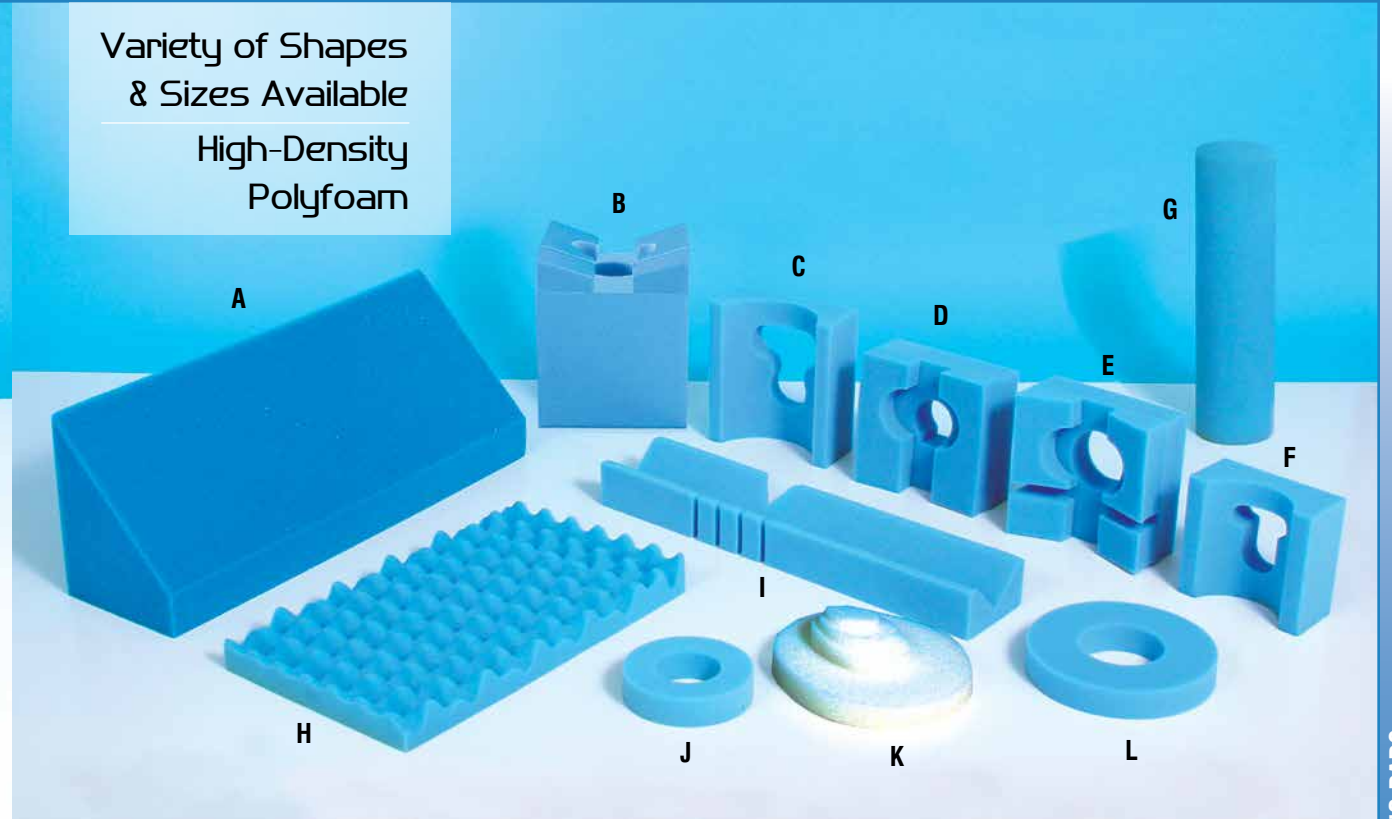

Ordering Information

Reusable antimicrobial coated positioners ideal for extremity positioning. The positioners are radiolucent and the coating is impregnated with Agion antimicrobial ionic silver that inhibits the growth of bacteria.

Item #	Description	Dimensions
A. #508-0355	Double Angle Wedge, 35°/55°	24"L x 9¾"W x 6¾"H (61 cm x 25 cm x 17 cm)
#508-0356	Angle Wedge, 45°	24"L x 7"W x 7"H (61 cm x 18 cm x 18 cm)
#508-0357	Wedge, 15°	10½"L x 9¾"W x 2¾"H (27 cm x 25 cm x 7 cm)
B. #508-0358	Double Angle, 55°/35°	14"L x 9½"W x 6½"H (36 cm x 24 cm x 17 cm)
#508-0359	Wedge, 20°	11"L x 8½"W x 3¾"H (28 cm x 22 cm x 10 cm)
#508-0360	Head & Neck	10¾"L x 7"W x 6"H (27 cm x 18 cm x 15 cm)
C. #508-0361	Head Support, Occipital Adult	10"L x 10"W x 4"H (25 cm x 25 cm x 10 cm)
D. #508-0364	Semicircle	14"L x 8½"W x 4½"H (36 cm x 22 cm x 11 cm)
#508-0365	Rolls, Small	24"L x 6"D (61 cm x 15 cm)
#508-0366	Rolls, Large	24"L x 8"D (61 cm x 20 cm)
E. #508-0367	Donut, Large, 6 pk.	9"D x 1½"H (23 cm x 4 cm)
#508-0368	Donut, Small, 6 pk.	6"D x 1½"H (15 cm x 4 cm)
F. #508-0362	Rectangular, Large	14"L x 9¼"W x 2"H (36 cm x 24 cm x 5 cm)
#508-0363	Rectangular, Small	9½"L x 7"W x 2"H (24 cm x 18 cm x 5 cm)

Ordering Information

These high-density Polyfoam positioning pads are supportive, comfortable and economical for all your positioning requirements. Available in a variety of shapes and sizes. Custom sizes available. Please call for a quote.

Item #	Description	Dimensions
A #508-0369	Disposable Wedge Pad, Large	24"L x 9¾"W x 6¾"H (61 cm x 25 cm x 17 cm)
#508-0386	Disposable Wedge Pad, Small	24"L x 7"W x 7"H (61 cm x 18 cm x 18 cm)
#508-0387	Disposable Body Aligner Wedge Pad	28"L x 8"W x 10"H (71 cm x 20 cm x 25 cm)
#508-0388	Disposable Body Aligner Half Wedge Pad	14"L x 8"W x 10"H (36 cm x 20 cm x 25 cm)
B #508-1340	Disposable Richard Slotted Headrests Positioning Pads, Extended, 6/cs	10"H x 8"W x 8"L (25 cm x 20 cm x 20 cm)
C #508-0381	Disposable Head Supports, Adult, 12/cs	9"L x 8"W x 3½"H (23 cm x 20 cm x 9 cm)
D #508-0374	Disposable Richards Headrests, 6/cs	8½"L x 8"W x 3¾"H (22 cm x 20 cm x 10 cm)
E #508-0375	Disposable Richards Slotted Headrests, 6/cs	8½"L x 8"W x 3¾"H (22 cm x 20 cm x 10 cm)
F #508-0382	Disposable Head Supports, Pediatric, 24/cs	6½"L x 7"W x 3¼"H (17 cm x 18 cm x 8 cm)
G #508-0379	Disposable Chest Rolls, 12/cs	5"D x 17"L (13 cm x 43 cm)
H #508-0380	Disposable Convuluted Pads, 12/cs	20"L x 12"W x 2"H (51 cm x 31 cm x 5 cm)
I #508-0373	Disposable Laminectomy Arm Cradles, 12 pr/cs	5"W x 24"L x 3"H (13 cm x 61 cm x 8 cm)
J #508-0371	Disposable Donut Pads, Small, 36/cs	1½"H x 6"D (4 cm x 15 cm)
K #508-0372	Disposable Donut Pads, Super, 36/cs	9"W x 10"L x 1"H (23 cm x 25 cm x 3 cm)
L #508-0370	Disposable Donut Pads, Large, 24/cs	1½"H x 9"D (4 cm x 23 cm)

COATED POSITIONING PADS

DISPOSABLE POSITIONING PADS

 PATIENT TRANSFER DEVICES

PATIENT TRANSFER DEVICES 



Transfer patients sitting up with ease



Schure Slide FTS

- No-lift transfer of bariatric patients
- Flexible for increased patient comfort
- Lightweight and radiolucent
- Long and short models available
- Wiped Clean
- MR-safe
- Antistatic

Schure Slide FTS (Flexible Track System) with conveyor belt mechanics allow for a safe and smooth transfer of your patients with just a slight push. No lifting is required reducing strain on the back, neck and shoulders while the flexible core allows for comfortable patient transference.

Choice of Short or Long model provides for easy transfer and storage. The Schure Slide FTS includes carry handles for easy transport.

**#800-0352** Schure Slide FTS, Short  
36"L x 20"W (91 cm x 51 cm)

**#800-0353** Schure Slide FTS, Long  
64"L x 16"W (163 cm x 41 cm)



Schure Slide XLT



Schure Slide XL



Schure Slide, Ergo



Schure Slide, Full-Size

**SCHURE SLIDE**  
patient transfer system

Schure Slide is smooth surfaced, flexible, and extremely durable. After being placed under a patient, personnel can effortlessly slide the patient from one gurney or table to another. The Full-Size Schure Slide enables personnel to easily slide the patient from one bed to another. Choose Flexible or Rigid. Patented.

- Reduce back injuries and increase comfort
- Non-disposable, no need to waste red bags
- Won't stain—spray and wipe clean
- Speed up turnover time—hang Schure Slide in every OR
- Radiolucent & not made w/natural rubber latex

Ordering Information

- #800-0072** Schure Slide XL, 33"L x 22"W x 1/16" (84 cm x 56 cm x .2 cm)
- #800-0071** Schure Slide, Rigid, 33"L x 22"W x 3/16" (84 cm x 56 cm x .5 cm)
- #800-0162** Schure Slide, Ergo, 33"L x 23"W x 1/16" (84 cm x 58 cm x .2 cm)
- #800-0067** Schure Slide, Anti-Static, Flexible, 33"L x 22"W x 1/16" (84 cm x 56 cm x .2 cm)
- #800-0068** Schure Slide, Anti-Static, Rigid, Black, 33"L x 22"W x 3/16" (84 cm x 56 cm x .5 cm)
- #800-0069** Schure Slide, Full Size, 72"L x 22"W x 3/16" (183 cm x 56 cm x .5 cm)
- #800-0070** Schure Slide, Full Size, Anti-Static, Rigid, Black, 72"L x 22"W x 3/16" (183 cm x 56 cm x .5 cm)
- #800-0120** Schure Slide XLT, 72"L x 22"W x 3/16" (183 cm x 56 cm x .5 cm)

PATIENT TRANSFER DEVICES

PATIENT TRANSFER DEVICES

## FLAT ARMBEARD PADS

**Armboard Pads** SchureMed offers a full range of armboard surfaces for any type of armboard in both flat and contoured styles to increase patient arm stability. The Softcare and Softcare Plus Surfaces are designed to reduce pressure and should be part of your pressure management strategy.

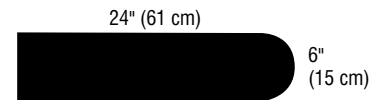

Fits most models: Getinge, Maquet, MDT & Champagne Armboards

### Flat Surface Armboard Pads

Pad Size	DELUXE			DELUXE GEL			
	2" (5 cm)	3" (8 cm)	4" (10 cm)	2.25" (6 cm)	3.25" (8 cm)	4.25" (11 cm)	5.25" (13 cm)
Allen, Steris-Amsco	#508-0912	#508-0913	#508-0914	#508-0931	#508-0932	#508-0933	#508-0934
Berchtold	#508-0938	#508-0939	#508-0940	#508-0957	#508-0958	#508-0959	#508-0960
Maquet	#508-0964	#508-0965	#508-0966	#508-0983	#508-0984	#508-0985	#508-0986
Midmark	#508-0990	#508-0991	#508-0992	#508-1009	#508-1010	#508-1011	#508-1012
Getinge/Shampaine	#508-1016	#508-1017	#508-1018	#508-1035	#508-1036	#508-1037	#508-1038
Skytron	#508-1042	#508-1043	#508-1044	#508-1061	#508-1062	#508-1063	#508-1064

Pad Size	SOFTCARE				SOFTCARE PLUS			
	2" (5 cm)	3" (8 cm)	4" (10 cm)	5" (13 cm)	2.25" (6 cm)	3.25" (8 cm)	4.25" (11 cm)	5.25" (13 cm)
Allen, Steris-Amsco	#508-0915	#508-0916	#508-0917	#508-0918	#508-0923	#508-0924	#508-0925	#508-0926
Berchtold	#508-0941	#508-0942	#508-0943	#508-0944	#508-0949	#508-0950	#508-0951	#508-0952
Maquet	#508-0967	#508-0968	#508-0969	#508-0970	#508-0975	#508-0976	#508-0977	#508-0978
Midmark	#508-0993	#508-0994	#508-0995	#508-0996	#508-1001	#508-1002	#508-1003	#508-1004
Getinge/Shampaine	#508-1019	#508-1020	#508-1021	#508-1022	#508-1027	#508-1028	#508-1029	#508-1030
Skytron	#508-1045	#508-1046	#508-1047	#508-1048	#508-1053	#508-1054	#508-1055	#508-1056

## CONTOURED ARMBEARD PADS

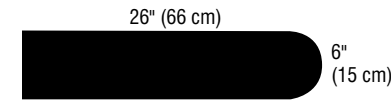

Fits most models: Allen, Schaerer Mayfield, Amsco, Siemens, Berchtold and Steris Armboards

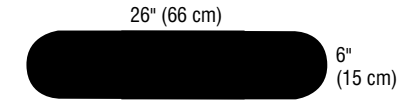

Fits most models: Skytron and SchureMed Armboards

### Contoured Surface Armboard Pads

Pad Size	DELUXE			DELUXE GEL			
	2" (5 cm)	3" (8 cm)	4" (10 cm)	2.25" (6 cm)	3.25" (8 cm)	4.25" (11 cm)	5.25" (13 cm)
Allen, Steris-Amsco	#508-1068	#508-1069	#508-1070	#508-1087	#508-1088	#508-1089	#508-1090
Berchtold	#508-1094	#508-1095	#508-1096	#508-1113	#508-1114	#508-1115	#508-1116
Maquet	#508-1120	#508-1121	#508-1122	#508-1139	#508-1140	#508-1141	#508-1142
Midmark	#508-1146	#508-1147	#508-1148	#508-1165	#508-1166	#508-1167	#508-1168
Getinge/Shampaine	#508-1172	#508-1173	#508-1174	#508-1191	#508-1192	#508-1193	#508-1194
Skytron	#508-1198	#508-1199	#508-1200	#508-1217	#508-1218	#508-1219	#508-1220

Pad Size	SOFTCARE				SOFTCARE PLUS			
	2" (5 cm)	3" (8 cm)	4" (10 cm)	5" (13 cm)	2.25" (6 cm)	3.25" (8 cm)	4.25" (11 cm)	5.25" (13 cm)
Allen, Steris-Amsco	#508-1071	#508-1072	#508-1073	#508-1074	#508-1079	#508-1080	#508-1081	#508-1082
Berchtold	#508-1097	#508-1098	#508-1099	#508-1100	#508-1105	#508-1106	#508-1107	#508-1108
Maquet	#508-1123	#508-1124	#508-1125	#508-1126	#508-1131	#508-1132	#508-1133	#508-1134
Midmark	#508-1149	#508-1150	#508-1151	#508-1152	#508-1157	#508-1158	#508-1159	#508-1160
Getinge/Shampaine	#508-1175	#508-1176	#508-1177	#508-1178	#508-1183	#508-1184	#508-1185	#508-1186
Skytron	#508-1201	#508-1202	#508-1203	#508-1204	#508-1209	#508-1210	#508-1211	#508-1212



 **PRODUCT INDEX**

**PRODUCT INDEX** 

**PRODUCT INDEX - ALPHABETICALLY**

Adjustable Footboard/ Table Extension.....30	Dolly, Stirrup ..... 9-11	Schure Loc™ XPS TKR Positioner.....21	508-0105 Deluxe Extra-Wide Armboard Pad.....32
Anesthesia Screen .....38	E-Z Lift Beach Chair ..... 18-19	Schure Slide, Anti-Static, Rigid, Black.....45	508-0106 Deluxe Hourglass Procedure Table Pad..... 35
Armboard, Adjustable Height.....32	Elbow Arthroscopy Support.....38	Schure Slide, Ergo .....45	508-0108 Deluxe Multi-Axis Arm Positioner Pad.....34
Armboard, Extra-Wide, Adjustable.....32	End Rest Procedure Table Deluxe Pad.....35	Schure Slide, Full Size, Anti-Static, Black.....45	508-0109 Narrow Head Rest Pad.....31
Armboard, Extra-Wide.....32	Extremity Positioner .....41	Schure Slide, Full Size.....45	508-0111 SchureFoot Disposable Pads.....24
Armboard, Incline Pad.....33	Finger Traps, Limited-Use .....39	Schure Slide, Rigid.....45	508-0115 Lateral Brace Round Pad .....27
Armboard, Radiolucent.....33	Foot Extensions, Reg. & Bariatric .....30, 31	Schure Slide, XL.....45	508-0116 Lateral Brace Rectangle Pad.....27
Armboard, Standard.....32	Hourglass Procedure Table Deluxe Pad.....35	Schure Slide, XLT.....45	508-0144 Toboggan Arm/Leg Guard Pads, Large.....38
Armboard Pad, Deluxe .....32,33	Knee Crutches .....13	Schure Slides FTS, Short & Long .....44	508-0145 Toboggan Arm/Leg Guard Pads, Medium .38
Armboard Pad, Deluxe Extra-Wide.....32	Knee Crutch Pads .....13	Schure Slide XLA Ambulance; Flexible, Rigid, Full-Size ..45	508-0151 Armboard Pad, Softcare.....32,33
Armboard Pad, Softcare .....32,33	Lateral Arm Support.....34	Schure Spine Frame.....26	508-0152 Extra-Wide Armboard Pad, Softcare .....32
Armboard Pad, Softcare Extra-Wide .....32	Lateral Brace Rectangle Pad.....27	Schure Spine Frame Crank Handle .....26	508-0154 Knee Crutch Pads .....13
Armboard Pad, Softcare Extra-Wide .....32	Lateral Brace Round Pad.....27	Schure Spine Frame Pad Set.....26	508-0155 Toboggan Arm/Leg Guard Pads, Small.....38
Armboard Pads, Flat & Contoured ..... 46-47	Lateral Braces .....27	Schure Strap Brand Rolls .....37	508-0156 Lateral Positioner Pad .....27
Armboard Wall Rack.....33	Lateral Positioner Pad .....27	Split Leg Footboards .....13	508-0159 Universal Prepper Pads .....36
Arthroscopic Leg Holder.....25	Lateral Positioners .....27	Stirrups, Candy Cane .....13	508-0350 YelloFin Boot Pads .....9
Bariatric Foot Extension Pad.....31	Leg Prepper .....36	Stirrups, Great White® HD 1000 Stirrup Boot System.... 6-7	508-0352 Well Leg Holder .....41
Bariatric Maxima Boot Pads .....7, 11	Leg Prepper Pad & Cover.....36	Stirrups, Great White® Maxima.....11	508-0353 Extremity Positioner .....41
Bariatric Nissen Straps.....40	Major Procedure Table Deluxe Pad.....35	Stirrups, Great White® Platinum..... 8-9	508-0355 Double Angle Wedge, 35°/55° Coated Positioning Pad.....42
Bi-Lateral Prepper .....36	Minor Procedure Table Deluxe Pad.....35	Stirrups, Great White® Premium .....10	508-0356 Angle Wedge, 45° Coated Positioning Pad .....42
Bi-Lateral Prepper Pad .....36	Multi-Axis Arm Positioner.....34	Stirrups, Great White® Robotic .....12	508-0357 Wedge, 15° Coated Positioning Pad.....42
Boot Pads with Fins .....7, 9,10,12	Multi-Axis Arm Positioner Pad.....34	Stirrups, Lithotomy .....12	508-0358 Double Angle, 55°/35° Coated Positioning Pad.....42
Boot Pads without Fins .....7, 10,12	Narrow Head Rest.....31	Stirrups, Pediatric E-Z Lift, PUPS & KIDS.....14	508-0359 Wedge, 20° Coated Positioning Pad.....42
Candy Cane Stirrup Strap.....13	Narrow Head Rest Pad.....31	Stirrups, Pediatric Lithotomy .....14	508-0360 Head & Neck Coated Positioning Pad.....42
Clamp, CamLoc Rail .....28	Nissen Straps .....40	Stirrups, Split Leg Stirrups.....13	508-0361 Head Support, Occipital Adult Coated Positioning Pad.....42
Clamp, Deluxe Rail.....29	Powered Beach Chair..... 16-17	Stirrup Wall Rack .....9, 10	508-0362 Rectangular, Large Coated Positioning Pad .....42
Clamp, Schure Socket.....29	Premium Head & Chin Straps.....37	Surgical Peg Board System.....27	508-0363 Rectangular, Small Coated Positioning Pad .....42
Clamp, Schure Socket XL.....28	Procedure Table, End Rest w/Leg.....35	Table Width Extensions .....31	508-0364 Semicircle Coated Positioning Pad .....42
Clamp, Simple .....29	Procedure Table, Hourglass w/Leg.....35	TKR Boot Liners, Sterile .....23	508-0365 Rolls, Small Coated Positioning Pad.....42
Clamp, Split Leg.....13	Procedure Table, Major w/Leg.....35	TKR Positioners, 24" & 30" ..... 22-23	508-0366 Rolls, Large Coated Positioning Pad.....42
Clamp, SpringLoc .....28	Procedure Table, Minor.....35	Toboggan Arm/Leg Guards & Pads.....38	508-0367 Donut, Large, Coated Positioning Pad.....42
Clamp, Universal Rail.....29	PUPS & KIDS Boot Pads.....14	Universal Prepper.....36	508-0368 Donut, Small, Coated Positioning Pad.....42
Clear View Leg Drapes .....15	Restraint Strap Mounting Hook.....40	Universal Prepper Pad.....36	508-0369 Disposable Wedge Positioning Pads.....43
Coated Positioning Pads .....42	Restraint Straps, Reg. & Bariatric .....40	Uro-Trapper Drain Bags.....15	508-0373 Disposable Laminectomy Arm Cradles .....26,43
Comfort Mat .....39	Safety Draw, IV Pole & Mayo Stand Mounts .....39	Uro-Trapper System.....15	508-0374 Disposable Richards Headrests .....43
Complete Shoulder System w/Schure Loc™ XPS.....17	Saphenous Vein Harvest Pad.....41	Well Leg Holder .....41	508-0375 Disposable Richards Slotted Headrests .....43
Disposable A-line Positioners .....40	SchureFoot, Lexan & Stainless Steel.....24	Wrist Rest .....31	508-0379 Disposable Chest Rolls .....43
Disposable Face Masks.....37	SchureFoot Disposable Pads.....24	Wrist Tower .....39	508-0380 Disposable Convoluted Pads .....43
Disposable Laminectomy Arm Cradles .....26	Schure Grip Leg Holder .....25	YelloFin Boot Pads .....9	508-0381 Disposable Head Supports, Adult .....43
Disposable Positioning Pads .....43	Schure Loc™ XPS..... 20-21		508-0382 Disposable Head Supports, Pediatric .....43
Disposable Premium Pads .....25	Schure Loc™ XPS Adapter.....21		508-0385 Saphenous Vein Harvest Pad.....41
Disposable Richard Slotted Head Rests, Extended .....26	Schure Loc™ XPS Armboard .....21		
Dolly, Lithotomy Stirrup.....12, 14	Schure Loc™ XPS Counter Traction Post .....21		
Dolly, Pediatric Stirrup.....14	Schure Loc™ XPS Elbow/Ankle Positioner .....21		
Dolly, Robotic Stirrup.....12	Schure Loc™ XPS Forearm Attachment.....21		
Dolly, Schure Spine Frame .....26	Schure Loc™ XPS Sterile Kit.....21		
Dolly, Shoulder Chair.....17, 19			

**PRODUCT INDEX - LISTED BY CATALOG #**

508-0071 Deluxe Armboard Pad .....32,33	508-0374 Disposable Richards Headrests .....43
508-0072 Minor Procedure Table Deluxe Pad.....35	508-0375 Disposable Richards Slotted Headrests .....43
508-0073 Major Procedure Table Deluxe Pad.....35	508-0379 Disposable Chest Rolls .....43
508-0090 Foot Extension Pad .....30	508-0380 Disposable Convoluted Pads .....43
508-0101 End Rest Procedure Table Deluxe Pad .....35	508-0381 Disposable Head Supports, Adult .....43
508-0103 Disposable Premium Pads .....25	508-0382 Disposable Head Supports, Pediatric .....43
	508-0385 Saphenous Vein Harvest Pad.....41

PRODUCT INDEX

PRODUCT INDEX

 **PRODUCT INDEX**

**PRODUCT INDEX** 

508-0386	Disposable Wedge Pads, Small.....	43	800-0042	Lateral Braces.....	27
508-0387	Disposable Body Aligner Wedge Pads.....	42	800-0043	Lateral Positioners.....	27
508-0388	Disposable Body Aligner Half Wedge Pad.....	43	800-0049	Lithotomy Stirrups.....	12
508-0472	Schure Spine Frame Pad Set.....	26	800-0050	Multi-Axis Arm Positioner.....	34
508-1295, 508-1296	PUPS & KIDS Boot Pads.....	14	800-0052	Narrow Headrest.....	31
508-1340	Disposable Richard Slotted Headrests Positioning Pads, Extended.....	26,43	800-0055	Nissen Straps.....	40
508-1354	Premium Stirrup Boot Pads.....	7,10,12	800-0057	Restraint Straps.....	40
508-1355	Incline Armboard Pad.....	33	800-0059	Safety Draw, IV Pole Mount.....	39
508-1371	Bariatric Footboard Pad.....	31	800-0060	Safety Draw, Mayo Stand Mount.....	39
508-1399	Toboggan Arm/Leg Guard Pads, X-Lg.....	38	800-0062	SchureFoot, Stainless Steel.....	24
508-1415	Platinum Stirrup Boot Pads.....	7,9,10,12	800-0065	Schure Grip Leg Holder.....	25
508-1502	Bariatric Maxima Boot Pads w/Fins .....	7, 11	800-0067	Schure Slide, Anti-Static, Flexible.....	45
512-0015	Finger Traps, Unlimited-Use.....	39	800-0068	Schure Slide, Anti-Static, Rigid, Black.....	45
790-0006	Candy Cane Stirrup Strap.....	13	800-0069	Schure Slide, Full Size.....	45
790-0039	Schure Loc™ XPS Adapter.....	21	800-0070	Schure Slide, Full Size, Anti-Static, Black.....	45
790-0040	Schure Loc™ XPS Forearm Attachment .....	21	800-0071	Schure Slide, Rigid.....	45
790-0056	Schure Loc™ XPS Armboard.....	21	800-0072	Schure Slide, XL.....	45
790-0057	Schure Loc™ XPS Counter Traction Post .....	21	800-0074-L	Lithotomy Stirrup Dolly.....	12,14
790-0074	Leg Prepper Pad & Cover.....	36	800-0074-P	Pediatric Stirrup Dolly.....	14
790-0075	Schure Loc™ XPS Elbow/Ankle Positioner .....	21	800-0074-R	Robotic Stirrup Dolly.....	12
790-0077	Schure Loc™ XPS TKR Positioner.....	21	800-0074-SF	Schure Spine Frame Dolly.....	26
800-0004	Powered Beach Chair.....	16-17	800-0074-S	Stirrup Dolly.....	9,10,11
800-0006	Schure Socket.....	29	800-0074	Shoulder Chair Dolly.....	17, 19
800-0008	Standard Armboard.....	32	800-0077, 800-0079, 800-0081	Table Width Extensions.....	31
800-0009	Adjustable Height Armboard.....	32	800-0082, 800-0083, 800-0084	Toboggan Arm/Leg Guards.....	38
800-0011	SchureFoot, Lexan.....	24	800-0085	Universal Rail Clamp.....	29
800-0012	Candy Cane Stirrups.....	13	800-0086	Wrist Rest.....	31
800-0013	Leg Prepper.....	36	800-0095, 800-0098	Uro-Trapper Drain Bags.....	15
800-0016	Anesthesia Screen.....	38	800-0096	Uro-Trapper System.....	15
800-0017	Adjustable Extra-Wide Armboard.....	32	800-0097	Schure Slide XLA Ambulance, Flexible.....	45
800-0018	Extra-Wide Armboard.....	32	800-0118	Bariatric Nissen Straps.....	40
800-0023	Arthroscopic Leg Holder.....	25	800-0119	Bariatric Restraint Strap.....	40
800-0026-ER-CF, 800-0026-ER-P	End Rest Procedure Table w/Leg.....	35	800-0120	Schure Slide, XLT.....	45
800-0026-HG-CF, 800-0026-HG-P	Hourglass Procedure Table w/Leg.....	35	800-0120	Schure Slide, XLT.....	45
800-0026-MI-CF, 800-0026-MI-P	Minor Procedure Table.....	35	800-0126	Schure Slide XLA Ambulance, Full-Size, Rigid .....	45
800-0026-MJ-CF, 800-0026-MJ-P	Major Procedure Table w/Leg.....	35	800-0134	Schure Socket XL.....	28
800-0036	Foot Extension.....	30	800-0135	Wrist Tower.....	39
800-0041	Knee Crutches.....	13	800-0141	TKR Positioner, 24".....	22-23
			800-0142	E-Z Lift Beach Chair.....	18-19
			800-0143, 800-0144	A-Line Positioners.....	40
			800-0145	Comfort Mat.....	39
			800-0146	TKR Boot Liners.....	23
			800-0147, 800-0148, 800-0149, 800-0150	Schure Strap Brand Rolls.....	37

800-0160	Disposable Clear View Leg Drapes.....	15	800-0293, 800-0294	Complete Shoulder System.....	17
800-0161	Universal Prepper.....	36	800-0296	Armboard Holder.....	33
800-0162	Schure Slide, Ergo.....	45	800-0297	Radiolucent Armboard.....	33
800-0162	Schure Slide, Ergo.....	45	800-0324	Split Leg Footboards.....	13
800-0164	Disposable Face Masks.....	37	800-0326	Bariatric Foot Extension.....	31
800-0166	Schure Slide XLA Ambulance, Rigid.....	45	800-0338	SpringLoc Clamp.....	28
800-0168	Elbow Arthroscopy Support.....	38	800-0342-KIDS (250 lbs), 800-0342-PUPS (160 lbs)	Pediatric E-Z Lift Stirrups.....	14
800-0171	TKR Positioner, 30".....	22-23	800-0342-M	Great White® Maxima Stirrups.....	11
800-0228-US-SL	Split Leg Clamp.....	13	800-0342-PL	Great White® Platinum Stirrups.....	8-9
800-0228	Simple Clamp.....	29	800-0342-PR, 800-0342-PRF	Great White® Premium Stirrups.....	10
800-0233 (250 lbs), 800-0234-KIDS (160 LBS)	Pediatric Lithotomy Stirrups.....	14	800-0342-R, 800-0342-RF	Great White® Robotics Stirrups.....	12
800-0235	Schure Spine Frame.....	26	800-0342-SL	Split Leg Stirrups.....	13
800-0236	Bi-Lateral Leg Prepper.....	36	800-0352, 800-0353	Schure Slide FTS, Short & Long.....	44
800-0237	Pediatric Lithotomy Stirrups Bundle.....	14	800-0354	Surgical Peg Board System.....	27
800-0238	Pediatric E-Z Lift Stirrups Bundle.....	14	800-0364	Great White® HD 1000 Stirrup Boot System .....	6-7
800-0248	Deluxe Rail Clamp.....	29	800-0369	Premium Head & Chin Straps.....	37
800-0271	CamLoc Rail Clamp.....	28	811-0001	Lateral Arm Support.....	34
800-0276	Toboggan Arm/Leg Guard, X-Large.....	38			
800-0277	Schure Spine Frame Crank Handle.....	26			
800-0280	Schure Loc™ XPS.....	20-21			
800-0281	Disp. Schure Loc™ XPS Sterile Kit.....	21			
800-0284	Stirrup Wall Rack.....	9, 10			
800-0285	Adjustable Footboard/Table Extension.....	30			

**PRICING**

All prices are subject to change without notice.  
Please contact customer service for pricing at 781-236-4151.

**LIMITED WARRANTY POLICY**

The Limited Warranty covers any defects in material or workmanship of products under normal use and maintenance for 2 years. Limited Warranty on gel pads, pads and positioners is 1 year. Warranty does not cover misuse, abuse, neglect, lack of maintenance and/or failure to comply with safety and caution labels/warnings.

**RETURN POLICY (US Only)**

Purchased products in new, unmarked and in saleable condition can be returned within 30 days of the shipping/invoice date with a valid Return Merchandise Authorization (RMA) number. RMA's can be obtained by contacting Customer Service at: 888-724-8763. The RMA # must be visible on the outside of the packaging. A credit will be issued following inspection of the product(s). Products returned not in new condition are subject to a 20% restocking fee or may not be eligible for a credit. OR table pads, armboard pads, stretcher pads, foam positioning pads, gel pads, coated pads, disposables and custom products are not eligible for return, refund or exchange.



PRODUCT INDEX

PRODUCT INDEX



452 Randolph Street, Abington MA 02351



Visa, MasterCard, American Express & Discover Accepted

PRSRST STD  
U.S. POSTAGE  
PAID  
PERMIT #814  
ST CLOUD, MN

PH 781-236-4151

FAX 781-982-7001

[schuremed.com](http://schuremed.com)

*SchureMed—the Better Choice*



[schuremed.com](http://schuremed.com) > find, learn, compare and save!

